

IDEAONE 2022

.03

fami



INNOVATION
SINCE 1929.





CONSULENZA

Un particolare progetto che vorresti realizzare, una nuova area da allestire? I consulenti commerciali di Fami sono al tuo fianco per analizzare tutte le tue necessità e realizzare gli arredi ideali per la tua azienda.



GARANZIA

I **10 anni di garanzia** dei prodotti Fami sono la diretta espressione dell'utilizzo di materiali di qualità, della cura e dedizione nella produzione per rendere i nostri arredi affidabili e durevoli nel tempo.



ORDINI

Ordinare i prodotti Fami Ideaone non è mai stato così facile! Scegli i diversi arredi e contatta il tuo agente di zona o rivenditore per completare il tuo ordine. Oppure visita Fami Shop per acquistare in pochi click!



GAMMA COLORI

Arredi di colore diverso dal solito blu o grigio? I prodotti Fami Ideaone sono disponibili anche nella versione **bicolor** grigio chiaro e antracite per trasformare l'aspetto della tua azienda.



VALIDITÀ

Il catalogo Fami Ideaone ha validità **dal 02/04/2022 al 31/12/2022**. I prezzi si ritengono validi durante tale periodo, salvo possibili variazioni, errori tipografici e/o omissioni di stampa.



FILIALI E RIVENDITORI

Fami è sempre accanto a te! Negli anni abbiamo sviluppato quattro filiali europee oltre a un'ampia rete di rivenditori e distributori, sia in Italia che all'estero, per fornirti consulenza e assistenza ovunque tu sia.



ASSISTENZA

Per qualsiasi domanda, informazione o problema il nostro servizio di assistenza post-vendita è sempre a tua disposizione. In caso di prodotti danneggiati o rotti riceverai sempre dei ricambi originali Fami in sostituzione.

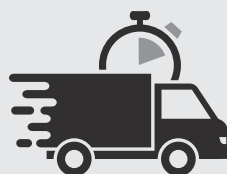

SPEDIZIONE

Gli arredi industriali Fami Ideaone sono disponibili con consegna entro 20 giorni lavorativi. **La spedizione è gratuita per ordini superiori a 250,00 € (isole escluse)**, mentre per importi minori il costo di gestione ordine è pari a **30,00 €**.



VASCHE DI RACCOLTA + RIPIANI E VASCHE PERFORM IN ACCIAIO

Idonee a liquidi infiammabili delle categorie GHS 1 - 3 e liquidi inquinanti per le acque delle categorie GHS 1 - 4. Non sono ammesse sostanze corrosive.



VASCHE DI RACCOLTA IN PE

Idonee a liquidi inquinanti per le acque delle categorie GHS 1 - 4. Non sono ammesse sostanze infiammabili.



CONSEGNE PORTO FRANCO in tutta Italia (isole escluse) per ordini a partire da 250 €. Per importi inferiori verrà applicato un contributo per costi di gestione di 30 €.

indice

BANCHI DA LAVORO

4

- WORK MASTER BR 4
- WORK - WORK UP 22
- DYNAMIC 38



ARMADI

90

- MASTER DE FLEXA 90
- POSTAZIONE PC MASTER CS
POSTAZIONE PC STANDARD CS 102



PARETI ATTREZZATE

46

- WORK LOOK 46
- COMPONENTS 60
- ERGO WORK 64
- UNIPOK 78
- IRON TEAM
IRON TEAM electric
IRON TEAM light 80

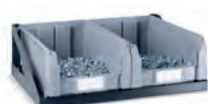

ARMADI CON PORTE

106

- PERFOM porte a battente 106
- PERFOM porte scorrevoli 132
- PERFOM armadi spogliatoio 136



NC

- PORTAUTENSILI 140



140

SCAFFALI

- ST 170



170

- DOMINO 172



ECOLOGIA

- BENNE
PORTAFUSTI
ARMADI PORTE A BATTENTE 144



144

CASSETTE E CONTENITORI

- CASSETTE E
CONTENITORI
IN METALLO 176



176

- CASSETTE E
CONTENITORI
IN PLASTICA
TAPPETI
ANTISDRUCCIOLO 182



CARRELLI

- CLEVER 150



150

- COMBI 161



- BIN CART 162



WORK MASTER BR

BANCHI DA LAVORO



Guarda il video!

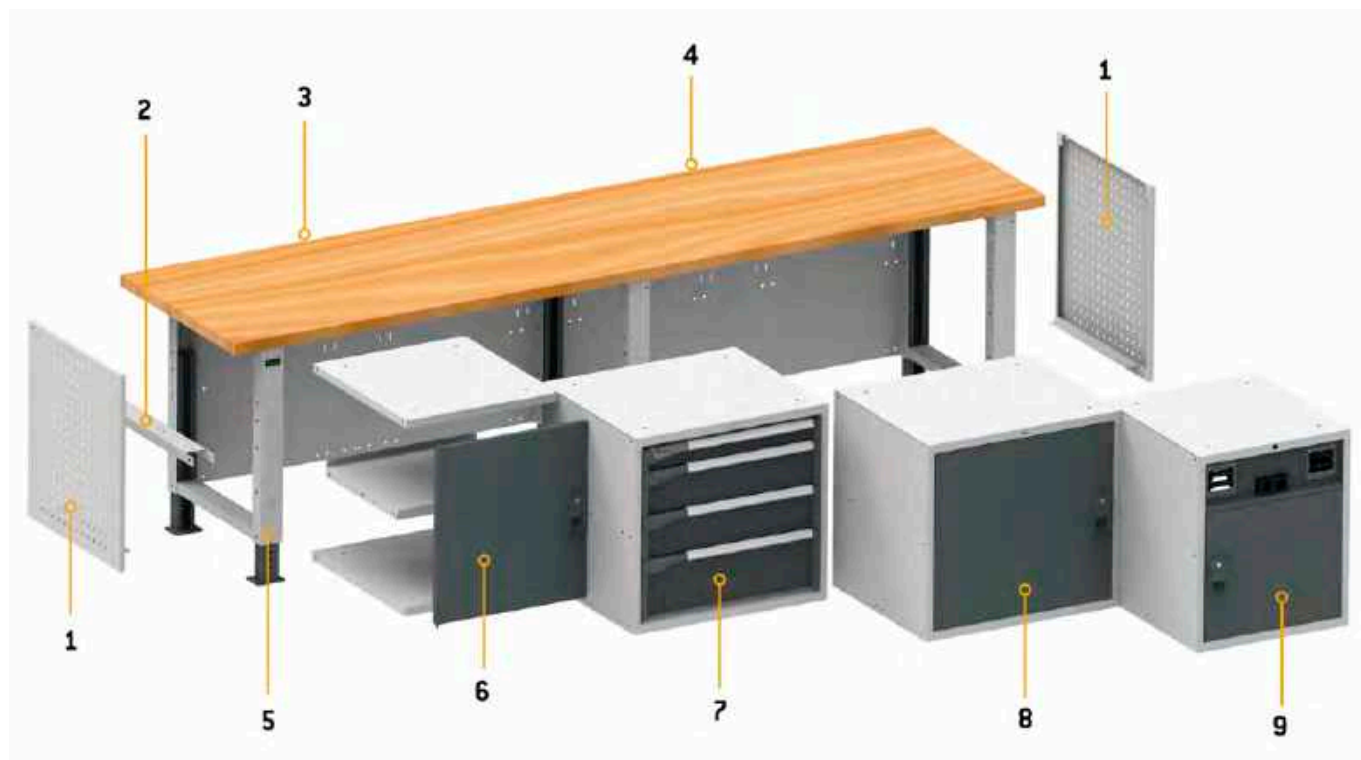

1. Pannello forato laterale
2. Supporto semipiano intermedio
3. Chiusura posteriore
4. Piano in Multiplex
5. Gambe regolabili
6. Modulo componibile
7. Armadio a cassette
8. Armadio con porta
9. Armadio tecnico con porta



CASSETTI AD
ESTRAZIONE TOTALE

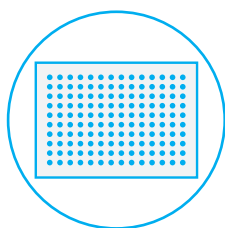

FONDO CASSETTO
FORATO



MATERIALE DI
SEPARAZIONE



CHIUSURA A CHIAVE

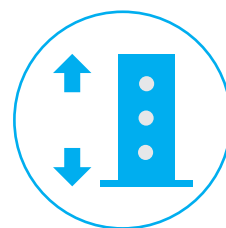

GAMBE REGOLABILI IN
ALTEZZA

WORK MASTER BR



ART.	Lmm	Pmm	Hmm	KG	RAL	€
MASTERBR2007	2206	750	1805/2180	1000	7035+7016	2622,00

Composto da:

qtà	descrizione
1	Banco smontato con piano in multiplex 40 mm
1	Armadio L=560 mm con 4 cassetti 1x75 2x150 1x200
4	Piano superiore/inferiore L=560 mm
1	Porta totale destra H=600 mm con maniglia Dark Grey
1	Porta totale sinistra H=600 mm con maniglia Dark Grey
2	Supporto semipiano intermedio
2	Piano interno L=558 mm
2	Pannello forato laterale
1	Pannello forato/mensola con 1 bordo fermacasse
1	Kit 3 montanti biasolati
1	Kit 2 pannelli forati/mensole con 1 bordo fermacasse
1	Pannello forato electric



qtà	descrizione
2	Pensile vasistas senza serratura
2	Coppia staffe di fissaggio pensile su montanti
2	Barra led sotto pensile
2	Multipresa schuko a 2 scomparti
1	Multipresa schuko a 4 scomparti
1	Magnetotermico differenziale
1	Cavo di collegamento wieland schuko/francese
1	Tasca porta documenti A4
1	Kit porta rotolo con carta Ø=240 mm
2	Porta bombolette inclinato a 2 posti
5	Gancio Unipok per utensili - confezione 30 pezzi
1	Cestino capacità 30 L

RAL 7035 + RAL 7016

PORTATA

WORK MASTER BR

1500

 **1000 KG**  **REGOLABILI IN ALTEZZA**  **PIANO IN MULTIPLEX SPESSORE 40 MM**

 **FORNITI SMONTATI**  **PASSO FORI GAMBE 25 MM**



ART.	Lmm	Pmm	Hmm	RAL	€
MASTERBR1505	1500	750	740/1115	7035+7016	729,90

Composto da:

qtà	descrizione
1	Banco smontato con piano in multiplex 40 mm
1	Armadio L=560 mm con 3 cassetti 1x75 2x100
1	Coppia squadre di rinforzo



ART.	Lmm	Pmm	Hmm	RAL	€
MASTERBR1506	1500	750	740/1115	7035+7016	822,90

Composto da:

qtà	descrizione
1	Banco smontato con piano in multiplex 40 mm
1	Armadio L=560 mm con 4 cassetti 1x75 2x150 1x200
1	Coppia squadre di rinforzo



ART.	Lmm	Pmm	Hmm	RAL	€
MASTERBR1501	1500	750	740/1115	7035+7016	956,70

Composto da:

qtà	descrizione
1	Banco smontato con piano in multiplex 40 mm
1	Armadio L=560 mm con 4 cassetti 1x75 2x150 1x200
2	Semipiano aggiuntivo L=560 mm
1	Supporto semipiano intermedio
2	Pannello forato laterale

WORK MASTER BR

1500



1000 KG



REGOLABILI IN ALTEZZA



PIANO IN MULTIPLEX SPESSORE 40 MM



FORNITI SMONTATI



PASSO FORI GAMBE 25 MM



ART.	Lmm	Pmm	Hmm	RAL	€
MASTERBR1502	1500	750	740/1115	7035+7016	1043,40

Composto da:

qtà	descrizione
1	Banco smontato con piano in multiplex 40 mm
1	Armadio L=560 mm con 4 cassetti 1x75 2x150 1x200
2	Piano superiore/inferiore L=560 mm
1	Porta totale sinistra H=600 mm con maniglia Dark Grey
1	Supporto semipiano intermedio
1	Piano interno L=558 mm
2	Pannello forato laterale



ART.	Lmm	Pmm	Hmm	RAL	€
MASTERBR1503	1500	750	740/1115	7035+7016	1395,00

Composto da:

qtà	descrizione
1	Banco smontato con piano in multiplex 40 mm
1	Armadio L=560 mm con 4 cassetti 1x75 2x150 1x200
1	Armadio L=560 mm con 5 cassetti 1x75 3x100 1x200



ART.	Lmm	Pmm	Hmm	RAL	€
MASTERBR1504	1500	750	740/1115	7035+7016	933,00

Composto da:

qtà	descrizione
1	Banco smontato con piano in multiplex 40 mm
2	Armadio L=560 mm predisposto per porta con 1 cassetto H=150 mm
1	Porta parziale sinistra H=435 mm con maniglia Dark Grey
1	Porta parziale destra H=435 mm con maniglia Dark Grey



RAL 7035 + RAL 7016



PORTATA

1000 KG
 ↑
↓
 REGOLABILI IN ALTEZZA
 ■
PIANO IN MULTIPLEX SPESSORE 40 MM
—
FORNITI SMONTATI
⋮
PASSO FORI GAMBE 25 MM



ART.	Lmm	Pmm	Hmm	RAL	€
MASTERBR2005	2000	750	740/1115	7035+7016	774,90

Composto da:

qtà	descrizione
1	Banco smontato con piano in multiplex 40 mm
1	Armadio L=560 mm con 3 cassetti 1x75 2x100
1	Coppia squadre di rinforzo



ART.	Lmm	Pmm	Hmm	RAL	€
MASTERBR2006	2000	750	740/1115	7035+7016	867,90

Composto da:

qtà	descrizione
1	Banco smontato con piano in multiplex 40 mm
1	Armadio L=560 mm con 4 cassetti 1x75 2x150 1x200
1	Coppia squadre di rinforzo



ART.	Lmm	Pmm	Hmm	RAL	€
MASTERBR2001	2000	750	740/1115	7035+7016	1149,00

Composto da:

qtà	descrizione
1	Banco smontato con piano in multiplex 40 mm
1	Armadio L=560 mm con 4 cassetti 1x75 2x150 1x200
1	Armadio L=560 mm predisposto per porta con 1 piano regolabile
1	Porta totale sinistra H=600 mm con maniglia Dark Grey
2	Semipiano aggiuntivo L=560 mm



1000 KG



REGOLABILI IN ALTEZZA



PIANO IN MULTIPLEX SPESSORE 40 MM



FORNITI SMONTATI



PASSO FORI GAMBE 25 MM



ART.	L mm	P mm	H mm	RAL	€
MASTERBR2002	2000	750	740/1115	7035+7016	1497,00

Composto da:

qtà	descrizione
1	Banco smontato con piano in multiplex 40 mm
1	Armadio L=560 mm con 4 cassetti 1x75 2x150 1x200
1	Armadio L=560 mm con 5 cassetti 1x75 3x100 1x200
2	Semipiano aggiuntivo L=560 mm



ART.	L mm	P mm	H mm	RAL	€
MASTERBR2003	2000	750	740/1115	7035+7016	1318,80

Composto da:

qtà	descrizione
1	Banco smontato con piano in multiplex 40 mm
1	Armadio L=560 mm con 5 cassetti 1x75 3x100 1x200
4	Piano superiore/inferiore L=560 mm
1	Porta totale destra H=600 mm con maniglia Dark Grey
1	Porta totale sinistra H=600 mm con maniglia Dark Grey
2	Supporto semipiano intermedio
2	Piano interno L=558 mm
2	Pannello forato laterale



ART.	L mm	P mm	H mm	RAL	€
MASTERBR2004	2000	750	740/1115	7035+7016	1296,00

Composto da:

qtà	descrizione
1	Banco smontato con piano in multiplex 40 mm
3	Armadio L=560 mm predisposto per porta con 1 cassetto H=150 mm
1	Porta parziale destra H=435 mm con maniglia Dark Grey
2	Porta parziale sinistra H=435 mm con maniglia Dark Grey





RAL 7035 + RAL 7016



PORTATA

WORK MASTER BR

COMPONENTI

 **1000 KG**
  **REGOLABILI IN ALTEZZA**
  **PIANO IN MULTIPLEX SPESSORE 40 MM**
 **FORNITI SMONTATI**
  **PASSO FORI GAMBE 25 MM**



ART.	Lmm	Pmm	Hmm	piano		RAL	€
				materiale	mm		
MBR01S0V0V001PD	1024	750	740/1115	Multiplex	40	7035+7016	255,00



ART.	Lmm	Pmm	Hmm	piano		RAL	€
				materiale	mm		
MBR02S0V0V001PD	1500	750	740/1115	Multiplex	40	7035+7016	297,00



ART.	Lmm	Pmm	Hmm	piano		RAL	€
				materiale	mm		
MBR03S0V0V001PD	2000	750	740/1115	Multiplex	40	7035+7016	342,00



ART.	Lmm	Pmm	Hmm	piano		RAL	€
				materiale	mm		
MBR04S0V0V001PD	3000	750	740/1115	Multiplex	40	7035+7016	585,00

IMBALLO BANCO SMONTATO



COPPIA SQUADRE DI RINFORZO

ART.	Lmm	Pmm	Hmm	RAL	€
FBGKITS0008	145	39	145	7035	15,90

 Utilizzare una squadra per gamba se non è presente la cassettera o il piano (una coppia per banchi 1024/1500/2000, due coppie per banchi 3000)

WORK MASTER BR

COMPONENTI



COPERTURA PER PIANO IN MULTIPLEX

ART.	Lmm	Pmm	Hmm	adatto per	colore	€
FBL22300007	1028	754	22	Piano in multiplex	Nero	78,00
FBL22600007	1504	754	22	Piano in multiplex	Nero	108,00
FBL22900007	2004	754	22	Piano in multiplex	Nero	138,00
FBL23200007	3004	754	22	Piano in multiplex	Nero	189,90

SCHEMATECNICO

L → 1000 MM



L → 1500 MM

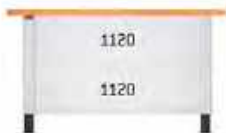

L → 2000 MM



L → 3000 MM



RAL 7035 + RAL 7016



RAL 7035



PORTATA



SPESSORE PIANO

ARMADI CON CASSETTI

L → 560 MM

27X27 EH



ARMADIO CON 3 CASSETTI

ART.	L mm	P mm	H mm	cassetti					RAL	€
				n.	h 75 mm	h 100 mm				
MBR05SC010203PD	560	610	369	3	1	2	100-75-50	92-96-100%	7035+7016	417,00



ARMADIO CON 4 CASSETTI

ART.	L mm	P mm	H mm	cassetti					RAL	€	
				n.	h 75 mm	h 150 mm	h 200 mm				
MBR05SC010204PD	560	610	669	4	1	2	1	100-75-50	92-96-100%	7035+7016	510,00



ARMADIO CON 5 CASSETTI

ART.	L mm	P mm	H mm	cassetti					RAL	€	
				n.	h 75 mm	h 100 mm	h 200 mm				
MBR05SC010205PD	560	610	669	5	1	3	1	100-75-50	92-96-100%	7035+7016	588,00



ARMADIO CON PIANO INTERMEDIO PREDISPOSTO PER PORTE

ART.	Lmm	Pmm	Hmm	piano regolabile	RAL	€
MBR05SX00020708	560	610	669	1	7035	186,00



PORTA TOTALE SINISTRA H=600 MM CON MANIGLIA DARK GREY

ART.	Lmm	Pmm	Hmm	apertura	RAL	€
MBR06SC01020239	504	34	600	Sinistra	7016	54,00



PORTA TOTALE DESTRA H=600 MM CON MANIGLIA DARK GREY

ART.	Lmm	Pmm	Hmm	apertura	RAL	€
MBR06SC01020139	504	34	600	Destra	7016	54,00

ARMADI CON CASSETTI

L → 560 MM

27X27 EH



ARMADIO TECNICO L=560 MM PREDISPOSTO PER PORTA

Adatto per porte Art. MBR06SC01020339 e Art. MBR06SC01020439

ART.	Lmm	Pmm	Hmm	KG	RAL	€
MBR05SX000208PD	560	610	669	100	7035+7016	189,00



ARROTOLATORE ELETTRICO CON PRESA SCHUKO

ART.	Lcavo m	tipo presa	Volt	Watt	€
MBR13SOV0V00100	20	Schuko	230	1600	414,00



ARROTOLATORE PER ARIA COMPRESSA

ART.	Lcavo m	Pressione max Mpa	Ø mm	€
MBR13SOV0V00200	14	1,5	10	198,00



RULLO PER ARROTOLATORE

ART.	€
MBR13SOV0V00339	25,50



PIASTRA PER ARROTOLATORE

Da fissare alla parte posteriore dell'armadio

ART.	€
MBR13SOV0V00499	19,50



1. Armadio tecnico L=560 mm predisposto per porta
2. Modulo: Rullo per arrotolatore

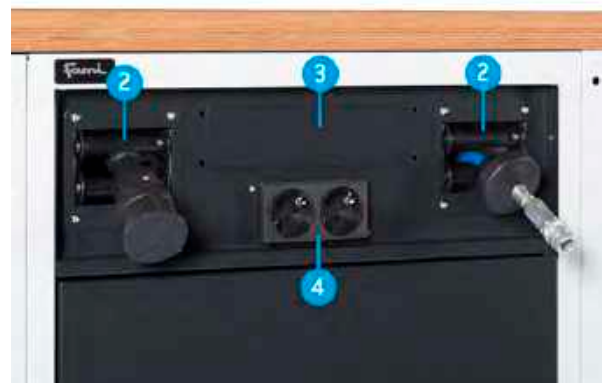

3. Modulo: Multipresa a 4 scomparti
4. Modulo: Multipresa a 2 scomparti



RAL 7035 + RAL 7016



RAL 7016



RAL 7035



ESTRAZIONE



PORTATA

ARMADI CON CASSETTI

L → 560 MM

27X27 EH



ARMADIO L=560 MM PREDISPOSTO PER PORTA CON 1 CASSETTO H=150 MM

ART.	Lmm	Pmm	Hmm	cassetti			RAL	€
				h 150 mm	KG	↓		
MBR05SC010206PD	560	610	669	1	100-75-50	92-96-100%	7035+7016	267,00



PORTA PARZIALE SINISTRA H=435 MM CON MANIGLIA DARK GREY

ART.	Lmm	Pmm	Hmm	apertura	RAL	€
MBR06SC01020439	504	34	435	Sinistra	7016	51,00



PORTA PARZIALE DESTRA H=435 MM CON MANIGLIA DARK GREY

ART.	Lmm	Pmm	Hmm	apertura	RAL	€
MBR06SC01020339	504	34	435	Destra	7016	51,00

ARMADI CON CASSETTI

L → 713 MM

36X27 EH



ARMADIO L=713 MM CON 4 CASSETTI 1X75 2X150 1X200

ART.	L mm	P mm	H mm	cassetti						RAL	€
				n.	h 75 mm	h 150 mm	h 200 mm	KG	↓		
MBR05SC010304PD	713	610	669	4	1	2	1	100-75-50	92-96-100%	7035+7016	540,00



ARMADIO L=713 MM CON 5 CASSETTI 1X75 3X100 1X200

ART.	L mm	P mm	H mm	cassetti						RAL	€
				n.	h 75 mm	h 100 mm	h 200 mm	KG	↓		
MBR05SC010305PD	713	610	669	5	1	3	1	100-75-50	92-96-100%	7035+7016	612,00

ARMADI CON CASSETTI

L → 713 MM

36X27 EH



ARMADIO L=713 MM PREDISPOSTO PER PORTA CON 1 PIANO REGOLABILE

ART.	L mm	P mm	H mm	piano regolabile	RAL	€
MBR05SX00030708	713	610	669	1	7035	198,00



PORTA TOTALE SINISTRA H=600 MM CON MANIGLIA DARK GREY

ART.	L mm	P mm	H mm	apertura	RAL	€
MBR06SC01030239	657	34	600	Sinistra	7016	57,00



PORTA TOTALE DESTRA H=600 MM CON MANIGLIA DARK GREY

ART.	L mm	P mm	H mm	apertura	RAL	€
MBR06SC01030139	657	34	600	Destra	7016	57,00



ARMADIO L=713 MM PREDISPOSTO PER PORTA CON 1 CASSETTO H=150 MM

ART.	L mm	P mm	H mm	cassetti			RAL	€
				h 150 mm	KG	ESTRAZIONE		
MBR05SC010306PD	713	610	669	1	100-75-50	92-96-100%	7035+7016	282,00



PORTA PARZIALE SINISTRA H=435 MM CON MANIGLIA DARK GREY

ART.	L mm	P mm	H mm	apertura	RAL	€
MBR06SC01030439	657	34	435	Sinistra	7016	54,00



PORTA PARZIALE DESTRA H=435 MM CON MANIGLIA DARK GREY

ART.	L mm	P mm	H mm	apertura	RAL	€
MBR06SC01030339	657	34	435	Destra	7016	54,00



RAL 7035 + RAL 7016



RAL 7016



RAL 7035



ESTRAZIONE



PORTATA



PANNELLO FORATO LATERALE

ART.	Lmm	Pmm	Hmm	Dim. foro mm	RAL	€
FBG15S00V0V0008	610	75	669	10x10	7035	42,00



PIANO AGGIUNTIVO

ART.	Lmm	Pmm	Hmm	KG	RAL	€
MBR08S070600008	713	605	35	250	7035	42,00
MBR08S090600008	967	605	35	250	7035	52,50
MBR08S110600008	1120	605	35	250	7035	52,50
MBR08S120600008	1273	605	35	250	7035	55,50
MBR08S160600008	1680	605	35	200	7035	70,50



SEMIPIANO AGGIUNTIVO

ART.	Lmm	Pmm	Hmm	KG	RAL	€
MBR09S050300008	560	305	35	100	7035	28,50
MBR09S070300008	713	305	35	100	7035	28,50
MBR09S090300008	967	305	35	100	7035	31,50
MBR09S110300008	1120	305	35	100	7035	31,50
MBR09S120300008	1273	305	35	100	7035	36,00
MBR09S160300008	1680	305	35	100	7035	45,00



SUPPORTO SEMIPIANO INTERMEDIO

ART.	Lmm	Pmm	Hmm	RAL	€
FBG13S605V00008	605	77	35	7035	8,70

WORK MASTER BR

MODULO COMPONENTI

COMPONENTI



1. Piano interno 27x27 EH
2. Piano superiore e inferiore 27x27 EH
3. Supporto semipiano intermedio
4. Porta totale destra H=600 mm con maniglia Dark Grey
5. Porta totale sinistra H=600 mm con maniglia Dark Grey



PIANO INTERNO 27X27 EH

ART.	L mm	P mm	H mm	KG	RAL	€
MBR11SOV0020008	558	466	60	100	7035	27,30



PIANO SUPERIORE E INFERIORE 27X27 EH

ART.	L mm	P mm	H mm	KG	RAL	€
MBR10S050600008	560	610	32	100	7035	31,20



PORTA TOTALE DESTRA H=600 MM CON MANIGLIA DARK GREY

ART.	L mm	P mm	H mm	apertura	RAL	€
MBR06SC01020539	554	34	600	Destra	7016	54,00



SUPPORTO SEMIPIANO INTERMEDIO

ART.	Lmm	Pmm	Hmm	RAL	€
FBG13S605V00008	605	77	35	7035	8,70

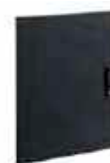

PORTA TOTALE SINISTRA H=600 MM CON MANIGLIA DARK GREY

ART.	L mm	P mm	H mm	apertura	RAL	€
MBR06SC01020639	554	34	600	Sinistra	7016	54,00



WORK MASTER BR

MATERIALE DI SEPARAZIONE L → 560 MM

COMPONENTI

27X27 EH

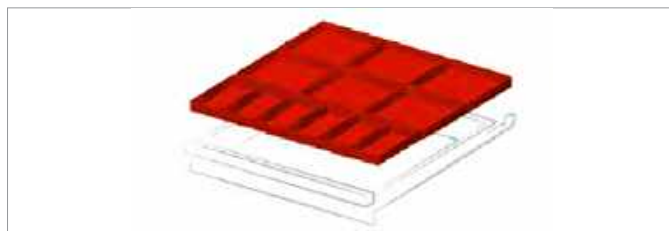
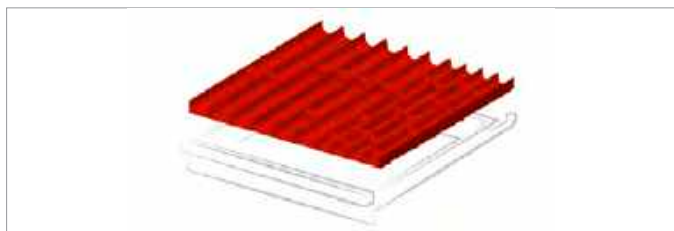

ART.	adatto per cassetto H mm	componenti	€
FFH84050200	50/300	16 x Divisorio trasversale L=36 mm 7 x Divisorio trasversale L=47 mm 6 x Divisorio a 3 canali 3 x Divisorio a 4 canali	19,50

ART.	adatto per cassetto H mm	componenti	€
FFH84071800	75	6 x Cassetta divisorio 150x75 mm	18,90
FFH84101800	100/125	6 x Cassetta divisorio 150x150 mm	22,50

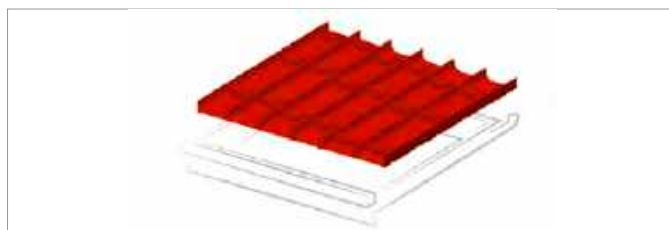
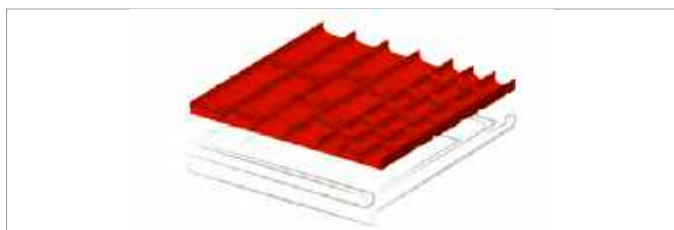

ART.	adatto per cassetto H mm	componenti	€
FFH84050300	50/300	15 x Divisorio trasversale L=47 mm 8 x Divisorio trasversale L=73 mm 6 x Divisorio a 2 canali 3 x Divisorio a 3 canali	19,50

ART.	adatto per cassetto H mm	componenti	€
FFH84050400	50/300	18 x Divisorio trasversale L=73 mm 9 x Divisorio a 2 canali	18,60



ART.	adatto per cassetto H mm	componenti	€
FFH84070800	75	2 x Divisorio longitudinale	11,70
FFH84100800	100/125	fessurato L=457 mm	14,70
FFH84150800	150/175	3 x Divisorio trasversale L=151 mm	19,20
FFH84200800	200/250		27,90

WORK MASTER BR

MATERIALE DI SEPARAZIONE L → 713 MM

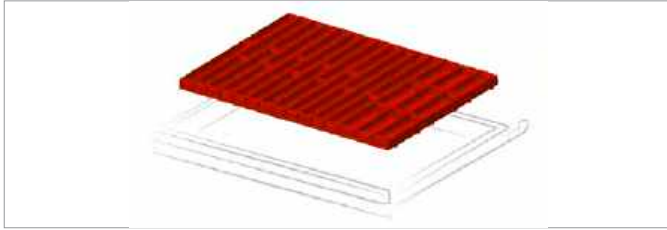

ART.	adatto per cassetto H mm	componenti	€
FFH10051000	50/300	3 x Divisorio a 3 canali 9 x Divisorio a 4 canali 12 x Divisorio trasversale L=47 mm 36 x Divisorio trasversale L=36 mm	27,60

COMPONENTI

36X27 EH

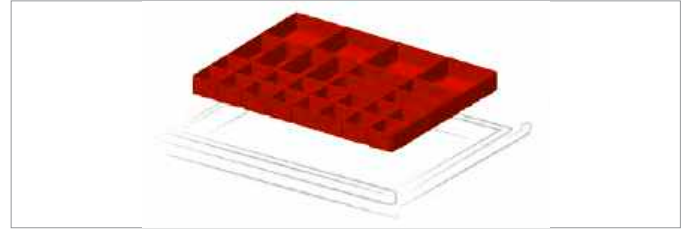

ART.	adatto per cassetto H mm	componenti	€
FFH10071800	75	16 x Cassetta divisorio 75x75 mm 8 x Cassetta divisorio 150x75 mm 4 x Cassetta divisorio 150x150 mm	27,90

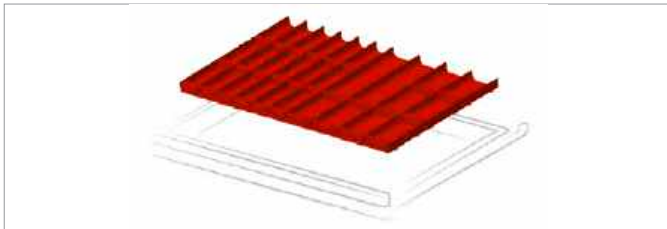

ART.	adatto per cassetto H mm	componenti	€
FFH10051300	50/300	18 x Divisorio trasversale L=47 mm 12 x Divisorio trasversale L=73 mm 6 x Divisorio a 2 canali 6 x Divisorio a 3 canali	24,60

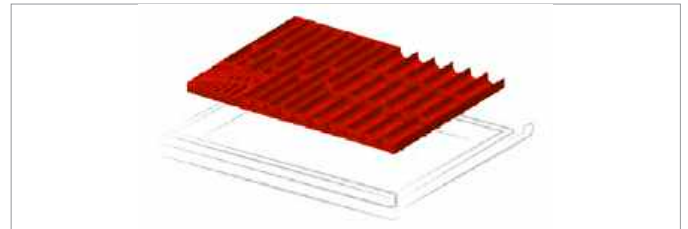

ART.	adatto per cassetto H mm	componenti	€
FFH10051500	50/300	20 x Divisorio trasversale L=36 mm 20 x Divisorio trasversale L=47 mm 6 x Divisorio a 3 canali 5 x Divisorio a 4 canali 1 x Porta chiavi a brugola	27,30

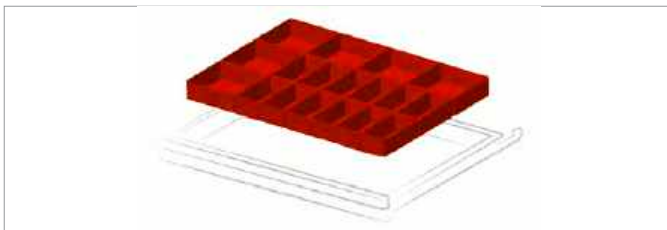

ART.	adatto per cassetto H mm	componenti	€
FFH10071600	75	12 x Cassetta divisorio 150x75 mm	24,60
FFH10101600	100/125	6 x Cassetta divisorio 150x150 mm	31,50



ART.	adatto per cassetto H mm	componenti	€
FFH10070500	75	2 x Divisorio longitudinale fessurato L=457 mm	14,70
FFH10100500	100/125	3 x Divisorio trasversale L=202 mm	15,30
FFH10150500	150/175		20,40
FFH10200500	200/250		29,40

WORK MASTER BR



ART.	Lmm	Pmm	Hmm	KG	RAL	€
MASTERBR3001	3206	750	1985/2360	1000	7035+7016	4291,50

Composto da:

qtà	descrizione	qtà	descrizione
1	Banco smontato con piano in multiplex 40 mm	1	Tasca porta documenti A4
1	Armadio L=560 mm predisposto per porta con 1 piano regolabile	1	Kit porta rotolo con carta Ø=240 mm
2	Armadio L=713 mm con 4 cassetti 1x75 2x150 1x200	4	Porta bombolette inclinato a 2 posti
1	Armadio tecnico L=560 mm predisposto per porta	6	Gancio Unipok per utensili - confezione 30 pezzi
1	Porta parziale destra H=435 mm con maniglia Dark Grey	1	Barra aggancio con 4 contenitori Picking Box misura 1
1	Porta totale sinistra H=600 mm con maniglia Dark Grey	2	Mensola grande reversibile
2	Pannello forato laterale	1	Cestino capacità 30 L
1	Kit 3 montanti biasolati	3	Kit 2 contenitori Picking Box misura 3A2
2	Kit 3 pannelli forati/mensole con 2 bordi fermacasse	1	Piastra per arrotolatore
2	Lampada doppia	2	Rullo per arrotolatore
2	Pensile con porta	1	Arrotolatore per aria compressa
1	Multipresa schuko a 2 scomparti	1	Arrotolatore elettrico con presa Schuko
1	Cavo di collegamento wieland schuko/francese	1	Kit 3 supporti inclinati con 2 binari



WORK MASTER BR



ART.	Lmm	Pmm	Hmm	KG	RAL	€
MASTERBR1508	1706	750	1985/2360	1000	7035+7016	2056,50

Composto da:

qtà	descrizione
1	Banco smontato con piano in multiplex 40 mm
1	Armadio L=560 mm con 5 cassette 1x75 3x100 1x200
2	Piano superiore/inferiore L=560 mm
1	Porta totale sinistra H=600 mm con maniglia Dark Grey
1	Supporto semipiano intermedio
1	Piano interno L=558 mm
2	Pannello forato laterale
1	Supporto multipresa a 2 scomparti
1	Supporto multipresa a 4 scomparti
1	Multipresa schuko a 2 scomparti
1	Multipresa schuko a 4 scomparti

qtà	descrizione
1	Cavo di collegamento wieland schuko/francese
1	Tasca porta documenti A4
1	Kit porta rotolo con carta Ø=240 mm
2	Porta bombole inclinato a 2 posti
4	Gancio Unipok per utensili - confezione 30 pezzi
1	Cestino capacità 30 L
2	Pensile con porta
1	Lampada doppia
1	Kit 3 pannelli forati/mensole con 2 bordi fermacasse
1	Kit 2 supporti inclinati con binario
1	Kit 2 montanti biasolati

RAL 7035 + RAL 7016

PORTATA

WORK-WORK UP

BANCHI DA LAVORO



Guarda il video!

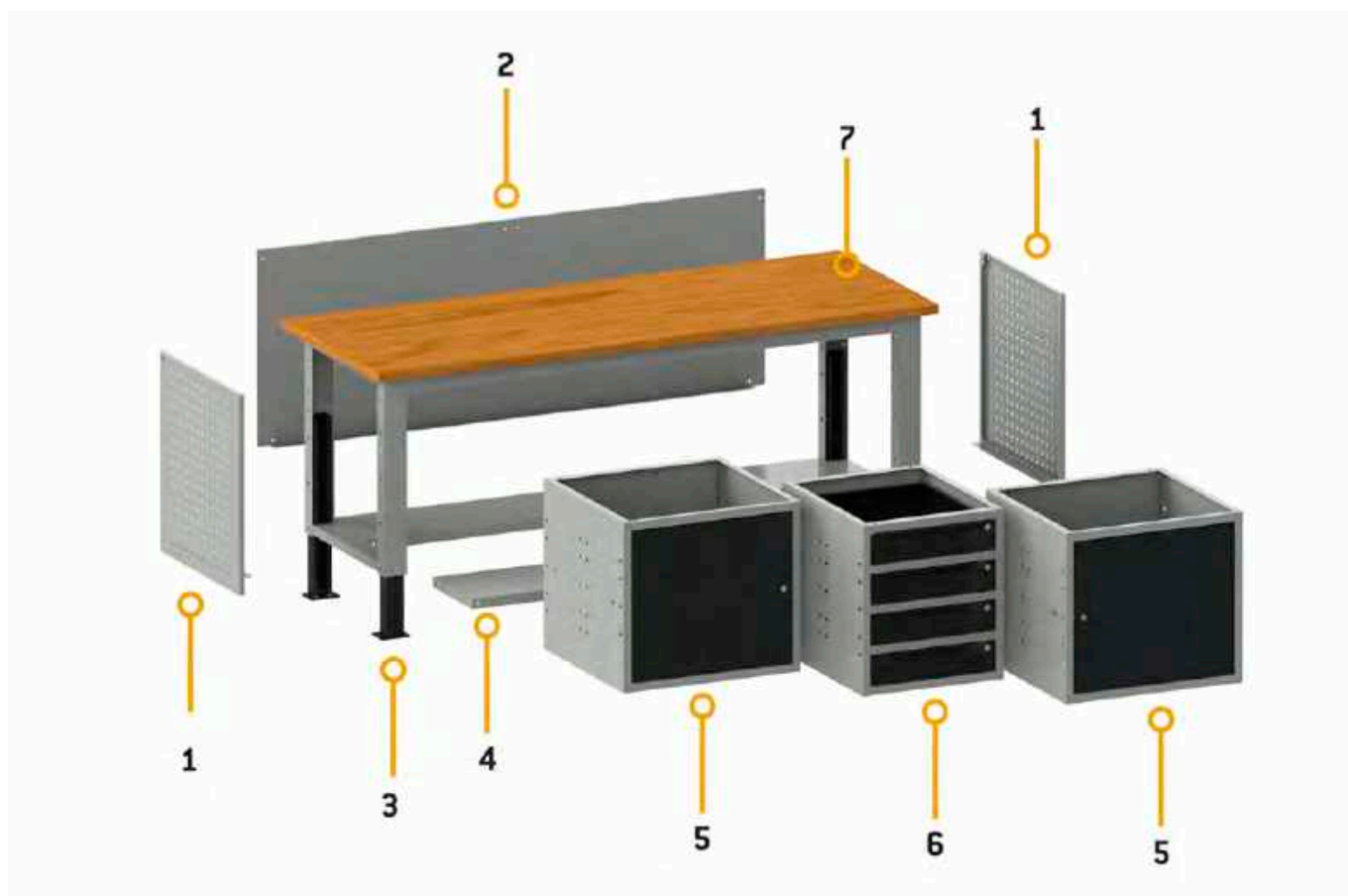

- 1. Pannello forato laterale
- 2. Chiusura posteriore
- 3. Gambe regolabili
- 4. Semipiano aggiuntivo

- 5. Armadio con porta
- 6. Armadio a 4 cassetti
- 7. Piano in Multiplex



CASSETTI AD
ESTRAZIONE
SEMPLICE

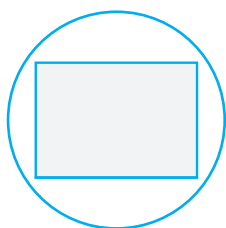

FONDO CASSETTO
LISCIO

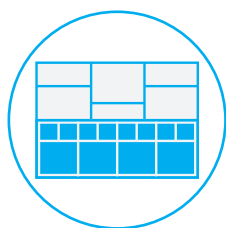

MATERIALE DI
SEPARAZIONE

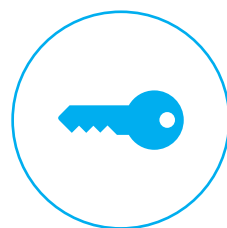

CHIUSURA A CHIAVE

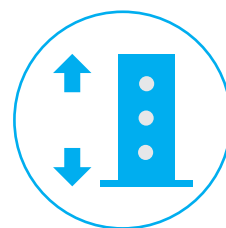

GAMBE REGOLABILI IN
ALTEZZA

WORK UP



ART.	Lmm	Pmm	Hmm	KG	RAL	€
WORK2013	2000	750	1977/2352	1000	7035+7016	2616,30

Composto da:

qtà	descrizione
1	Banco smontato regolabile con piano in multiplex 30 mm
1	Armadio L=500 mm con 4 cassetti H=105 mm
2	Armadio L=629 mm con 1 porta e 1 piano regolabile
1	Semipiano non fessurato L=1760 mm
2	Pannello forato laterale
1	Kit porta rotolo con carta Ø=240 mm
2	Tasca porta documenti A4
1	Kit 3 montanti biasolati
2	Kit 3 pannelli forati/mensole con 2 bordi fermacasse
1	Kit 3 supporti inclinati con 2 binari
2	Binario supplementare con attacchi
1	Set aria compressa con bilanciatore e filtro
1	Multipresa schuko a 2 scomparti

qtà	descrizione
1	Multipresa schuko a 4 scomparti
1	Magnetotermico differenziale
1	Cavo di collegamento wieland schuko/francese
1	Supporto multipresa a 2 scomparti
1	Supporto multipresa a 4 scomparti
1	Supporto per magnetotermico differenziale
1	Mensola grande reversibile
2	Porta bombolette inclinato a 2 posti
1	Cestino capacità 30 L
6	Gancio Unipok per utensili - confezione 30 pezzi
2	Kit 2 contenitori Picking Box misura 3A2
1	Lampada doppia

■
RAL 7035 + RAL 7016

KG
PORTATA

WORK UP 1500

1000 KG
 ↑ ↓ **REGOLABILI IN ALTEZZA**
 ■ **PIANO IN MULTIPLEX SPESSORE 30 MM**
— **FORNITI SMONTATI**
 ⋮ **PASSO FORI GAMBE 25 MM**



ART.	Lmm	Pmm	Hmm	RAL	€
WORK1501	1500	750	732/1107	7035+7016	393,90
WORK1502	1500	750	732/1107	5012	383,40

Composto da:

qtà	descrizione
1	Banco smontato regolabile con piano in multiplex 30 mm
1	Armadio L=500 mm con 1 cassetto H=150 mm



ART.	Lmm	Pmm	Hmm	RAL	€
WORK1503	1500	750	732/1107	7035+7016	656,40
WORK1504	1500	750	732/1107	5012	632,40

Composto da:

qtà	descrizione
1	Banco smontato regolabile con piano in multiplex 30 mm
1	Armadio L=500 mm con 4 cassetti H=105 mm
1	Semipiano non fessurato L=1260 mm



ART.	Lmm	Pmm	Hmm	RAL	€
WORK1507	1500	750	732/1107	7035+7016	710,10
WORK1508	1500	750	732/1107	5012	686,10

Composto da:

qtà	descrizione
1	Banco smontato regolabile con piano in multiplex 30 mm
1	Armadio L=500 mm con 4 cassetti H=105 mm
1	Chiusura posteriore
1	Semipiano non fessurato L=760 mm
1	Supporto semipiano intermedio

WORK UP 1500



1000 KG



REGOLABILI IN ALTEZZA



PIANO IN MULTIPLEX SPESSORE 30 MM



FORNITI SMONTATI



PASSO FORI GAMBE 25 MM



ART.	Lmm	Pmm	Hmm	RAL	€
WORK1505	1500	750	732/1107	7035+7016	785,40
WORK1506	1500	750	732/1107	5012	758,40

Composto da:

qtà	descrizione
1	Banco smontato regolabile con piano in multiplex 30 mm
1	Armadio L=500 mm con 4 cassetti H=105 mm
1	Armadio L=500 mm con 1 porta e 1 piano regolabile
1	Fondo di chiusura per armadio L=500 mm



ART.	Lmm	Pmm	Hmm	RAL	€
WORK1511	1500	750	732/1107	7035+7016	686,40
WORK1512	1500	750	732/1107	5012	668,40

Composto da:

qtà	descrizione
1	Banco smontato regolabile con piano in multiplex 30 mm
2	Armadio L=629 mm con 1 cassetto H=150 mm e 1 porta
1	Semipiano non fessurato L=1260 mm



ART.	Lmm	Pmm	Hmm	RAL	€
WORK1509	1500	750	732/1107	7035+7016	821,40
WORK1510	1500	750	732/1107	5012	794,40

Composto da:

qtà	descrizione
1	Banco smontato regolabile con piano in multiplex 30 mm
1	Armadio L=629 mm con 4 cassetti H=105 mm
1	Armadio L=629 mm con 1 porta e 1 piano regolabile
1	Semipiano non fessurato L=1260 mm





RAL 5012



RAL 7035 + RAL 7016

WORK UP 2000

 **1000 KG**
  **REGOLABILI IN ALTEZZA**
  **PIANO IN MULTIPLEX SPESSORE 30 MM**
 **FORNITI SMONTATI**
  **PASSO FORI GAMBE 25 MM**



ART.	Lmm	Pmm	Hmm	RAL	€
WORK2001	2000	750	732/1107	7035+7016	434,10
WORK2002	2000	750	732/1107	5012	426,60

Composto da:

qtà	descrizione
1	Banco smontato regolabile con piano in multiplex 30 mm
1	Armadio L=500 mm con 1 cassetto H=150 mm



ART.	Lmm	Pmm	Hmm	RAL	€
WORK2003	2000	750	732/1107	7035+7016	705,60
WORK2004	2000	750	732/1107	5012	684,60

Composto da:

qtà	descrizione
1	Banco smontato regolabile con piano in multiplex 30 mm
1	Armadio L=500 mm con 4 cassetti H=105 mm
1	Semipiano non fessurato L=1760 mm



ART.	Lmm	Pmm	Hmm	RAL	€
WORK2005	2000	750	732/1107	7035+7016	840,60
WORK2006	2000	750	732/1107	5012	816,60

Composto da:

qtà	descrizione
1	Banco smontato regolabile con piano in multiplex 30 mm
1	Armadio L=500 mm con 4 cassetti H=105 mm
1	Armadio L=500 mm con 1 porta e 1 piano regolabile
1	Semipiano non fessurato L=1760 mm

WORK UP 2000



1000 KG



REGOLABILI IN ALTEZZA



PIANO IN MULTIPLEX SPESSORE 30 MM



FORNITI SMONTATI



PASSO FORI GAMBE 25 MM



ART.	Lmm	Pmm	Hmm	RAL	€
WORK2007	2000	750	732/1107	7035+7016	924,60
WORK2008	2000	750	732/1107	5012	900,60

Composto da:

qtà	descrizione
1	Banco smontato regolabile con piano in multiplex 30 mm
1	Armadio L=500 mm con 4 cassetti H=105 mm
1	Armadio L=500 mm con 1 porta e 1 piano regolabile
1	Chiusura posteriore
1	Semipiano non fessurato L=760 mm
1	Fondo di chiusura per armadio L=500 mm



ART.	Lmm	Pmm	Hmm	RAL	€
WORK2011	2000	750	732/1107	7035+7016	897,60
WORK2012	2000	750	732/1107	5012	873,60

Composto da:

qtà	descrizione
1	Banco smontato regolabile con piano in multiplex 30 mm
1	Armadio L=500 mm con 1 cassetto H=150 mm e 1 porta
2	Armadio L=629 mm con 1 cassetto H=150 mm e 1 porta
1	Semipiano non fessurato L=1760 mm



ART.	Lmm	Pmm	Hmm	RAL	€
WORK2009	2000	750	732/1107	7035+7016	999,60
WORK2010	2000	750	732/1107	5012	972,60

Composto da:

qtà	descrizione
1	Banco smontato regolabile con piano in multiplex 30 mm
1	Armadio L=500 mm con 4 cassetti H=105 mm
2	Armadio L=629 mm con 1 porta e 1 piano regolabile
1	Semipiano non fessurato L=1760 mm



RAL 5012



RAL 7035 + RAL 7016

WORK UP COMPONENTI

 1000 KG	 REGOLABILI IN ALTEZZA	 PIANO IN MULTIPLEX SPESSORE 30 MM
 FORNITI SMONTATI	 PASSO FORI GAMBE 25 MM	 PIANO IN ACCIAIO SPESSORE 3 MM



BANCO WORK UP CON PIANO IN ACCIAIO

ART.	Lmm	Pmm	Hmm	piano		RAL	€
				materiale	mm		
FBG01S1000R00PD	1031	704	737/1112	Acciaio	3	7035+7016	256,20
FBG01S1000R0004	1031	704	737/1112	Acciaio	3	5012	243,90
FBG01S1500R00PD	1507	704	737/1112	Acciaio	3	7035+7016	308,70
FBG01S1500R0004	1507	704	737/1112	Acciaio	3	5012	290,40
FBG01S2000R00PD	2007	704	737/1112	Acciaio	3	7035+7016	348,90
FBG01S2000R0004	2007	704	737/1112	Acciaio	3	5012	333,60



BANCO WORK UP CON PIANO IN LEGNO

ART.	Lmm	Pmm	Hmm	piano		RAL	€
				materiale	mm		
FBG02S1000R00PD	1024	750	732/1107	Multiplex	30	7035+7016	256,20
FBG02S1000R0004	1024	750	732/1107	Multiplex	30	5012	243,90
FBG02S1500R00PD	1500	750	732/1107	Multiplex	30	7035+7016	296,40
FBG02S1500R0004	1500	750	732/1107	Multiplex	30	5012	290,40
FBG02S2000R00PD	2000	750	732/1107	Multiplex	30	7035+7016	336,60
FBG02S2000R0004	2000	750	732/1107	Multiplex	30	5012	333,60



IMBALLO BANCO SMONTATO



KIT RUOTE

Adatte solo per i banchi Work Up



ART.	Ø mm	KG	H mm	materiale			€
FKRU1252101	125	300	155	Gomma antitraccia sintetica	2	2	46,20
FKRS1252101	125	750	155	Gomma elastica	2	2	75,90



RUOTA GIREVOLE CON FRENO



RUOTA FISSA



COPPIA SQUADRE DI RINFORZO

ART.	L mm	P mm	H mm	RAL	€
FBGKITS0008	145	39	145	7035	15,90
FBGKITS0004	145	39	145	5012	15,90

 Utilizzare una coppia squadre per gamba se non è presente la cassetteria

WORK COMPONENTI



1000 KG

PIANO IN MULTIPLEX SPESSORE 30 MM



FORNITI SMONTATI

PIANO IN ACCIAIO SPESSORE 3 MM



BANCO WORK CON PIANO IN ACCIAIO

ART.	Lmm	Pmm	Hmm	piano		RAL	€
				materiale	mm		
FBG01S1000F00PD	1031	704	887	Acciaio	3	7035+7016	216,00
FBG01S1000F0004	1031	704	887	Acciaio	3	5012	210,00
FBG01S1500F00PD	1507	704	887	Acciaio	3	7035+7016	274,80
FBG01S1500F0004	1507	704	887	Acciaio	3	5012	262,50
FBG01S2000F00PD	2007	704	887	Acciaio	3	7035+7016	321,30
FBG01S2000F0004	2007	704	887	Acciaio	3	5012	305,70



BANCO WORK CON PIANO IN LEGNO

ART.	Lmm	Pmm	Hmm	piano		RAL	€
				materiale	mm		
FBG02S1000F0008	1024	750	882	Multiplex	30	7035	210,00
FBG02S1000F0004	1024	750	882	Multiplex	30	5012	210,00
FBG02S1500F0008	1500	750	882	Multiplex	30	7035	262,50
FBG02S1500F0004	1500	750	882	Multiplex	30	5012	262,50
FBG02S2000F0008	2000	750	882	Multiplex	30	7035	305,70
FBG02S2000F0004	2000	750	882	Multiplex	30	5012	305,70

IMBALLO BANCO SMONTATO



COPERTURA PER PIANO IN ACCIAIO

ART.	Lmm	Pmm	Hmm	adatto per	colore	€
FBG32100007	1024	702	27	Piano in acciaio	Nero	78,00
FBG32150007	1500	702	27	Piano in acciaio	Nero	108,00
FBG32200007	2000	702	27	Piano in acciaio	Nero	138,00



COPERTURA PER PIANO IN MULTIPLEX

ART.	Lmm	Pmm	Hmm	adatto per	colore	€
FBL22300007	1028	754	22	Piano in multiplex	Nero	78,00
FBL22600007	1504	754	22	Piano in multiplex	Nero	108,00
FBL22900007	2004	754	22	Piano in multiplex	Nero	138,00
FBL23200007	3004	754	22	Piano in multiplex	Nero	189,90



RAL 5012



RAL 7035



RAL 7035 + RAL 7016



SPESSOREPIANO



PORTATA

1000



1500

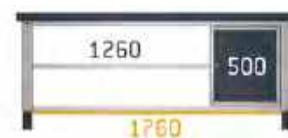

ARMADI CON CASSETTI

L → 500 MM

ARMADIO CON 1 CASSETTO



ART.	L mm	P mm	Hmm	cassetti				porta		RAL	€
				n.	KG	hmm	n.	h ingresso mm			
FBG03S50C0001PD	500	630	210	1	25	86%	150	-	-	7035+7016	97,50
FBG03S50C000104	500	630	210	1	25	86%	150	-	-	5012	93,00

ARMADIO CON 3 CASSETTI



ART.	L mm	P mm	Hmm	cassetti				porta		RAL	€
				n.	KG	hmm	n.	h ingresso mm			
FBG03S50C0002PD	500	630	570	3	25	86%	150	-	-	7035+7016	237,00
FBG03S50C000204	500	630	570	3	25	86%	150	-	-	5012	223,50

ARMADIO CON 4 CASSETTI



ART.	L mm	P mm	Hmm	cassetti				porta		RAL	€
				n.	KG	hmm	n.	h ingresso mm			
FBG03S50C0003PD	500	630	570	4	25	86%	105	-	-	7035+7016	324,00
FBG03S50C000304	500	630	570	4	25	86%	105	-	-	5012	306,00

ARMADIO CON 1 CASSETTO E 1 PORTA



ART.	L mm	P mm	Hmm	cassetti				porta		RAL	€
				n.	KG	hmm	n.	h ingresso mm			
FBG03S50C0004PD	500	630	570	1	25	86%	150	1	310	7035+7016	162,00
FBG03S50C000404	500	630	570	1	25	86%	150	1	310	5012	153,00

⚠ Senza fondo di chiusura

ARMADIO CON 1 PORTA E 1 PIANO



ART.	L mm	P mm	Hmm	cassetti				porta		RAL	€
				n.	KG	hmm	n.	h ingresso mm			
FBG03S50C0005PD	500	612	570	-	-	-%	-	1	491	7035+7016	135,00
FBG03S50C000504	500	612	570	-	-	-%	-	1	491	5012	132,00

⚠ Senza fondo di chiusura

FONDO DI CHIUSURA

FONDO DI CHIUSURA PER ARMADI L= 500 MM



ART.	Lmm	Pmm	Hmm	RAL	€
FBG16S50V0V0008	494	572	4	7035	30,00
FBG16S50V0V0004	494	572	4	5012	30,00

Da utilizzare sull'armadio con porta quando è presente il semipiano

FONDO DI CHIUSURA PER ARMADI L= 629 MM



ART.	Lmm	Pmm	Hmm	RAL	€
FBG16S63V0V0008	623	572	4	7035	30,00
FBG16S63V0V0004	623	572	4	5012	30,00

Da utilizzare sull'armadio con porta quando è presente il semipiano



ARMADI CON CASSETTI

L → 629 MM



ARMADIO CON 3 CASSETTI

ART.	L mm	P mm	Hmm	cassetti				porta		RAL	€
				n.	KG	%	h mm	n.	h ingresso mm		
FBG03S63C0002PD	629	630	570	3	25	86%	150	-	-	7035+7016	264,00
FBG03S63C000204	629	630	570	3	25	86%	150	-	-	5012	249,00



ARMADIO CON 4 CASSETTI

ART.	L mm	P mm	Hmm	cassetti				porta		RAL	€
				n.	KG	%	h mm	n.	h ingresso mm		
FBG03S63C0003PD	629	630	570	4	25	86%	105	-	-	7035+7016	342,00
FBG03S63C000304	629	630	570	4	25	86%	105	-	-	5012	324,00



ARMADIO CON 1 CASSETTO E 1 PORTA

ART.	L mm	P mm	Hmm	cassetti				porta		RAL	€
				n.	KG	%	h mm	n.	h ingresso mm		
FBG03S63C0004PD	629	630	570	1	25	86%	150	1	310	7035+7016	177,00
FBG03S63C000404	629	630	570	1	25	86%	150	1	310	5012	171,00

Senza fondo di chiusura



ARMADIO CON 1 PORTA E 1 PIANO

ART.	L mm	P mm	Hmm	cassetti				porta		RAL	€
				n.	KG	%	h mm	n.	h ingresso mm		
FBG03S63C0005PD	629	612	570	-	-	-%	-	1	491	7035+7016	147,00
FBG03S63C000504	629	612	570	-	-	-%	-	1	491	5012	144,00

Senza fondo di chiusura

RAL 5012

RAL 7035

RAL 7035 + RAL 7016

PORTATA

ESTRAZIONE



CHIUSURA POSTERIORE

ART.	Lmm	Hmm	adatto per banco Lmm	RAL	€
FBG12S080000008	825	665	1024-1031	7035	43,50
FBG12S080000004	825	665	1024-1031	5012	43,50
FBG12S130000008	1325	665	1500-1507	7035	52,50
FBG12S130000004	1325	665	1500-1507	5012	52,50
FBG12S180000008	1825	665	2000-2007	7035	70,50
FBG12S180000004	1825	665	2000-2007	5012	70,50



COPIA TAMPONI LATERALI

Per banco L=1024-1031 mm con armadio L=629 mm

ART.	Lmm	Pmm	Hmm	RAL	€
FBG14S130V00008	65	35	568	7035	13,50
FBG14S130V00004	65	35	568	5012	13,50



PANNELLO FORATO LATERALE

ART.	Lmm	Pmm	Hmm	Dim. foro mm	RAL	€
FBG15S00V0V0008	610	75	669	10x10	7035	42,00
FBG15S00V0V0004	610	75	669	10x10	5012	42,00



PIANO NON FESSURATO AGGIUNTIVO

ART.	Lmm	Pmm	Hmm	KG	RAL	€
FBG08S070600108	760	600	35	250	7035	42,00
FBG08S070600104	760	600	35	250	5012	42,00
FBG08S120600108	1260	600	35	250	7035	55,50
FBG08S120600104	1260	600	35	250	5012	55,50
FBG08S170600108	1760	600	35	200	7035	70,50
FBG08S170600104	1760	600	35	200	5012	70,50



SEMIPIANO NON FESSURATO AGGIUNTIVO

ART.	Lmm	Pmm	Hmm	KG	RAL	€
FBG09S070300108	760	300	35	100	7035	28,50
FBG09S070300104	760	300	35	100	5012	28,50
FBG09S120300108	1260	300	35	100	7035	36,00
FBG09S120300104	1260	300	35	100	5012	36,00
FBG09S170300108	1760	300	35	100	7035	45,00
FBG09S170300104	1760	300	35	100	5012	45,00



SUPPORTO SOLO PER SEMIPIANO AGGIUNTIVO

ART.	Lmm	Pmm	Hmm	RAL	€
FBG13S605V00008	605	77	35	7035	8,70
FBG13S605V00004	605	77	35	5012	8,70



ART.	Lmm	Pmm	Hmm	KG	RAL	€
WORK2014	2007	704	737/1112	1000	7035+7016	1020,90

Composto da:

qtà	descrizione
1	Banco smontato regolabile con piano in acciaio 3 mm
1	Armadio L=500 mm con 4 cassette H=105 mm
1	Armadio L=500 mm con 1 porta e 1 piano regolabile
1	Chiusura posteriore
1	Semipiano non fessurato L=760 mm
1	Fondo di chiusura per armadio L=500 mm
2	Pannello forato laterale



RAL 7035



RAL 5012



RAL 7035 + RAL 7016



PORTATA

MATERIALE DI SEPARAZIONE

L → 500 MM

27X27 EH



ART.	adatto per cassetto H mm	n. divisori trasversali	€
FBG18S50DV00199	105/150	3	11,70



ART.	adatto per cassetto H mm	n. divisori trasversali	n. divisori longitudinali	€
FBG18S50DV00299	105/150	1	1	8,40



ART.	adatto per cassetto H mm	componenti	€
FBG18S50CD00103	105/150	4 x Cassetta divisorio 100x50 mm	6,90



ART.	adatto per cassetto H mm	componenti	€
FBG18S50CD00203	105/150	3 x Cassetta divisorio 100x50 mm 2 x Cassetta divisorio 150x75 mm 1 x Cassetta divisorio 150x150 mm	10,50



ART.	adatto per cassetto H mm	componenti	€
MATSEP001	105/150	1 x FBG18S50CD00103 1 x FBG18S50CD00203 1 x FBG18S50DV00299	25,80



ART.	adatto per cassetto H mm	componenti	€
MATSEP002	105/150	1 x FBG18S50CD00103 2 x FBG18S50CD00203 1 x FBG18S50DV00299	36,30



TAPPETO IN GOMMA

ART.	materiale	€
FBG18S50TP00107	Poliestere	4,20

MATERIALE DI SEPARAZIONE

L → 629 MM

36X27 EH



ART.	adatto per cassetto H mm	n. divisori trasversali	€
FBG18S63DV00199	105/150	3	12,60



ART.	adatto per cassetto H mm	n. divisori trasversali	n. divisori longitudinali	€
FBG18S63DV00299	105/150	1	1	9,00

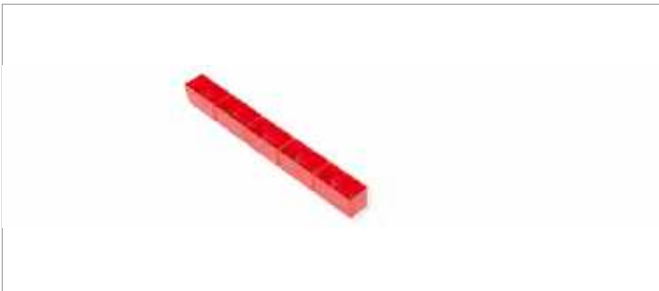

ART.	adatto per cassetto H mm	componenti	€
FBG18S63CD00103	105/150	5 x Cassetta divisorio 100x50 mm	8,70

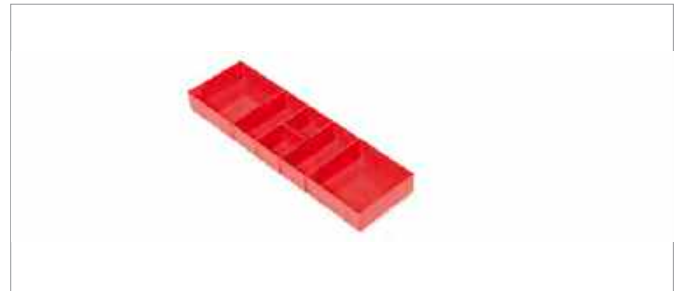

ART.	adatto per cassetto H mm	componenti	€
FBG18S63CD00203	105/150	2 x Cassetta divisorio 75x75 mm 2 x Cassetta divisorio 150x75 mm 2 x Cassetta divisorio 150x150 mm	10,50



ART.	adatto per cassetto H mm	componenti	€
MATSEP003	105/150	1 x FBG18S63CD00103 1 x FBG18S63CD00203 1 x FBG18S63DV00299	28,20



ART.	adatto per cassetto H mm	componenti	€
MATSEP004	105/150	1 x FBG18S63CD00103 2 x FBG18S63CD00203 1 x FBG18S63DV00299	38,70



TAPPETO IN GOMMA

ART.	materiale	€
FBG18S63TP00107	Poliestere	5,10



ART.	L mm	P mm	H mm	KG	RAL	€
WORK2015	2007	704	2098	1000	7035+7016	1907,40

Composto da:

qtà	descrizione
1	Banco smontato con piano in acciaio 3 mm
1	Armadio L=500 mm con 1 cassetto H=150 mm e 1 porta
2	Armadio L=629 mm con 1 cassetto H=150 mm e 1 porta
1	Mensola porta oggetti reversibile
2	Porta flacone igienizzante reversibile
1	Kit porta rotolo con carta Ø=130 mm
1	Kit 3 montanti biasolati
2	Kit 3 pannelli forati/mensole con 2 bordi fermacasse
1	Kit 3 supporti inclinati con 2 binari
2	Multipresa schuko a 2 scomparti

qtà	descrizione
2	Multipresa schuko a 4 scomparti
1	Magnetotermico differenziale
1	Cavo di collegamento wieland schuko/francese
2	Supporto multipresa a 2 scomparti
2	Supporto multipresa a 4 scomparti
1	Supporto per magnetotermico differenziale
2	Porta bombolette inclinato a 2 posti
6	Gancio Unipok per utensili - confezione 30 pezzi
2	Barra aggancio con 3 contenitori Picking Box misura 2
1	Lampada doppia

WORK UP



ART.	Lmm	Pmm	Hmm	KG	RAL	€
WORK1513	1500	750	1977/2352	1000	7035+7016	2070,90

Composto da:

qtà	descrizione
1	Banco smontato regolabile con piano in multiplex 30 mm
1	Armadio L=629 mm con 4 cassetti H=105 mm
1	Armadio L=629 mm con 1 porta e 1 piano regolabile
1	Fondo di chiusura per armadio L=629 mm
2	Pannello forato laterale
1	Kit 2 montanti biasolati
1	Kit 3 pannelli forati/mensole con 2 bordi fermacasse
1	Kit 2 supporti inclinati con binario
1	Binario supplementare con attacchi
1	Set aria compressa con bilanciatore e filtro
1	Multipresa schuko a 2 scomparti

qtà	descrizione
1	Multipresa schuko a 4 scomparti
1	Cavo di collegamento wieland schuko/francese
1	Supporto multipresa a 2 scomparti
1	Supporto multipresa a 4 scomparti
1	Mensola grande reversibile
1	Kit pronto soccorso
2	Porta bombole inclinato a 2 posti
1	Cestino capacità 30 L
3	Gancio Unipok per utensili - confezione 30 pezzi
2	Barra aggancio con 3 contenitori Picking Box misura 2
3	Kit 2 contenitori Picking Box misura 3A2
1	Lampada doppia

■ ■ ■
RAL 7035 + RAL 7016

KG
PORTATA

DYNAMIC

BANCHI DA LAVORO



- | | |
|-------------------|------------------------|
| 1. Tampono | 7. Piano in laminato |
| 2. USB Dati | 8. Angolare |
| 3. Telaio | 9. Supporto |
| 4. Magnetotermico | 10. Armadio a cassette |
| 5. Multiprese | 11. Tastierino |
| 6. USB Ricarica | |



PORTATA BANCO 400 KG

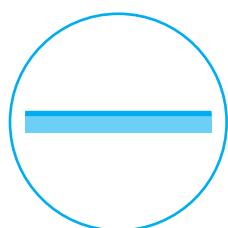

PIANO IN LAMINATO

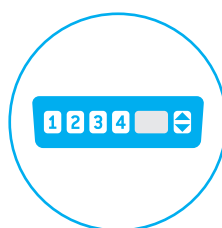

TASTIERINO CON 3 MEMORIE

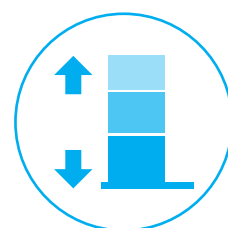

REGOLABILE IN ALTEZZA
ELETTRONICAMENTE

DYNAMIC



ART.	Lmm	Pmm	Hmm	KG	RAL	€
DYNAMIC1504	1497	780	740/1140	400	7035+7016	2377,50

Composto da:

qtà	descrizione
1	Banco smontato regolabile elettricamente
1	Armadio L=560 mm con 3 cassetti 1x75 2x100
1	Telaio portaprese aggiuntivo completo di tamponi e angolari
1	Coppia supporti per armadio
2	Multipresa schuko a 2 scomparti

qtà	descrizione
1	Multipresa schuko a 4 scomparti
1	Magnetotermico differenziale
1	Cavo di collegamento wieland con spine in/out
1	Cavo di collegamento wieland schuko/francese
1	Presse usb dati
1	Presse usb ricarica



RAL 7035 + RAL 7016



PORTATA



ART.	L mm	P mm	H mm	KG	RAL	€
DYNAMIC1501	1497	780	1983/2383	400	7035+7016	3129,90

Composto da:

qtà	descrizione	qtà	descrizione
1	Banco smontato regolabile elettricamente	2	Lampada singola
1	Armadio L=560 mm con 3 cassetti 1x75 2x100	1	Binario supplementare con attacchi
2	Pannello forato/mensola con 1 bordo fermacasse	1	Pres a usb ricarica
1	Kit 2 montanti biasolati	1	Pres a usb dati
1	Kit 2 supporti inclinati con binario	1	Cavo di collegamento wieland schuko/francese
1	Pannello forato electric	1	Magnetotermico differenziale
1	Lampada doppia	1	Multipresa schuko a 4 scomparti
1	Coppia supporti per armadio	2	Multipresa schuko a 2 scomparti
1	Telaio portaprese aggiuntivo completo di tamponi e angolari	36	Contenitore in polipropilene Picking Box misura 2



ART.	Lmm	Pmm	Hmm	KG	RAL	€
DYNAMIC1503	1497	780	1983/2383	400	7035+7016	3023,40

Composto da:

qtà	descrizione
1	Banco smontato regolabile elettricamente
1	Armadio L=500 mm con 1 cassetto H=150 mm
1	Binario supplementare con attacchi
1	Pannello forato/mensola
2	Pannello forato/mensola con 1 bordo fermacasse
1	Kit 2 montanti biasolati
1	Kit 2 supporti inclinati con binario
1	Mensola porta oggetti reversibile
1	Gancio Unipok per utensili - confezione 30 pezzi
1	Coperchio per armadio L=500 mm
2	Multipresa schuko a 2 scomparti
1	Multipresa schuko a 4 scomparti
1	Magnetotermico differenziale
1	Cavo di collegamento wieland schuko/francese
1	Presse usb dati
1	Presse usb ricarica
1	Pannello forato electric
1	Lampada doppia
3	Lampada singola
1	Telaio portaprese aggiuntivo completo di tamponi e angolari
1	Coppia supporti per armadio
36	Contenitore in polipropilene Picking Box misura 2



ART.	Lmm	Pmm	Hmm	KG	RAL	€
DYNAMIC1502	1497	780	1983/2383	400	7035+7016	2766,60

Composto da:

qtà	descrizione
1	Banco smontato regolabile elettricamente
2	Pensile con porta
1	Binario supplementare con attacchi
2	Pannello forato/mensola con 1 bordo fermacasse
1	Kit 2 montanti biasolati
1	Kit 2 supporti inclinati con binario
1	Pannello forato electric
1	Multipresa schuko a 4 scomparti
1	Magnetotermico differenziale
1	Cavo di collegamento wieland schuko/francese
1	Presse usb dati
1	Presse usb ricarica
1	Mensola porta oggetti reversibile
1	Lampada doppia
1	Lampada singola
1	Telaio portaprese aggiuntivo completo di tamponi e angolari
2	Multipresa schuko a 2 scomparti
18	Contenitore in polipropilene Picking Box misura 2



RAL 7035 + RAL 7016



PORTATA

DYNAMIC COMPONENTI

 400 KG



REGOLABILI IN ALTEZZA

 FORNITI SMONTATI



BANCO BASE CON TRAVERSO REVERSIBILE

ART.	Lmm	Pmm	Hmm	RAL	€
FLE0970E0PD	985	700	740/1140	7035+7016	1312,20
FLE1470E0PD	1470	700	740/1140	7035+7016	1402,80

1. Traverso reversibile



Il banco è dotato di gambe regolabili in altezza elettronicamente. L'altezza può variare da un minimo di 740 mm a un massimo di 1140 mm.



Il tastierino numerico consente di controllare il meccanismo di regolazione del banco. Oltre a consentire di modificare l'altezza del piano di lavoro, è dotato anche di 3 memorie di posizionamento per modificare rapidamente l'altezza del banco in base all'utilizzatore.

VISTA ANTERIORE DEL TRAVERSO



VISTA POSTERIORE DEL TRAVERSO



Il traverso del banco presenta delle incisioni per la collocazione delle prese elettriche e degli interruttori magnetotermici Iron Team Electric. In base alla dimensione scelta, il numero di intagli varia. I diversi componenti possono essere installati sia nella parte posteriore che anteriore del traverso.

Gli Iron Team Electric non sono compresi con il traverso.

SCHEMA PRESE TRAVERSO

1000



1 2 3 5 1

1500



1 2 3 4 5 1

1 foro per cavi

2 magnetotermico

3 multipresa 2 scomparti

4 multipresa 4 scomparti

5 centralina

DYNAMIC COMPONENTI



TELAIO PORTAPRESE AGGIUNTIVO COMPLETO DI TAMPONI ANGOLARI

ART.	Lmm	Pmm	Hmm	RAL	€
FBL46600008	1014	130	208	7035	60,00
FBL46650008	1499	130	208	7035	66,00

1. Traverso reversibile
2. Telaio
3. Angolari
4. Tamponi

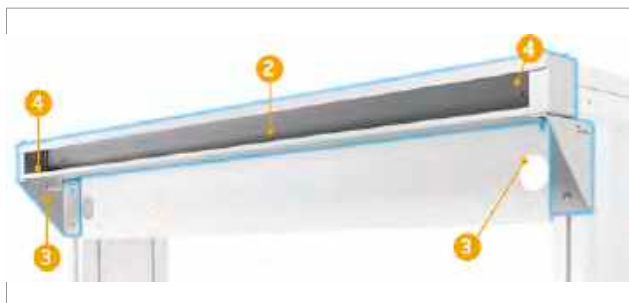

VISTA SUPERIORE DEL TELAI



VISTA INFERIORE DEL TELAI

Per il montaggio del montante Work Look è necessaria l'installazione del telaio aggiuntivo.



Il telaio reversibile per banco presenta delle incisioni per la collocazione delle prese elettriche e degli interruttori magnetotermici Iron Team Electric. In base alla dimensione scelta, il numero di intagli varia. I diversi componenti possono essere installati sia nella parte superiore che inferiore del telaio reversibile. Gli Iron Team Electric non sono compresi con il telaio aggiuntivo.

SCHEMA PRESE TELAI

1000

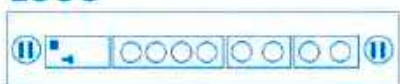

- 1
- 2
- 4
- 3
- 3
- 5

1500



- 1
- 2
- 4
- 3
- 3
- 5

1 USB dati

2 magnetotermico

3 multipresa 2 scomparti

4 multipresa 4 scomparti

5 USBricarica

RAL 7035

RAL 7035 + RAL 7016

PORTATA



ARMADIO CON 3 CASSETTI



ART.	Lmm	Pmm	Hmm	cassetti				RAL	€	
				n.	h 75 mm	h 100 mm	KG			
MBR05SC010203PD	560	610	369	3	1	2	100-75-50	92-96-100%	7035+7016	417,00

ARMADIO CON 1 CASSETTO



ART.	Lmm	Pmm	Hmm	cassetti				RAL	€
				n.	KG	hmm	hmm		
FBG03S50C0001PD	500	630	210	1	25	86%	150	7035+7016	97,50

COPERCHIO PER ARMADIO L=500 MM

Per armadio ad 1 cassetto

ART.	Lmm	Pmm	Hmm	RAL	€
FBL66900008	496	601	2	7035	27,00

COPPIA SUPPORTI PER ARMADIO

ART.	Lmm	Pmm	Hmm	RAL	€
FBL46010008	2	648	181	7035	21,00

IRON TEAM ELECTRIC



FBLET012007



FBLET004007



FBLET005007



FBLET016007



FBLET013007



FBLET020007



FBLET019007

vedi pag. 86

DYNAMIC COMPONENTI



Il banco regolabile in altezza elettronicamente Dynamic consente di creare una postazione di lavoro dinamica ed ergonomica, adatta all'impiego in numerosi settori. Per massimizzare il comfort dell'utilizzatore Dynamic offre numerose soluzioni: armadi con cassetti, telai aggiuntivi o traversi per componenti elettrici, pareti forate Work Look. Le gambe regolabili in altezza sono controllate da un pratico tastierino numerico. L'altezza del banco può essere regolata al millimetro da un minimo di 740 mm ad un massimo di 1140 mm. Consente di memorizzare tre altezze diverse per regolare in velocità e semplicità il piano di lavoro in poche mosse.

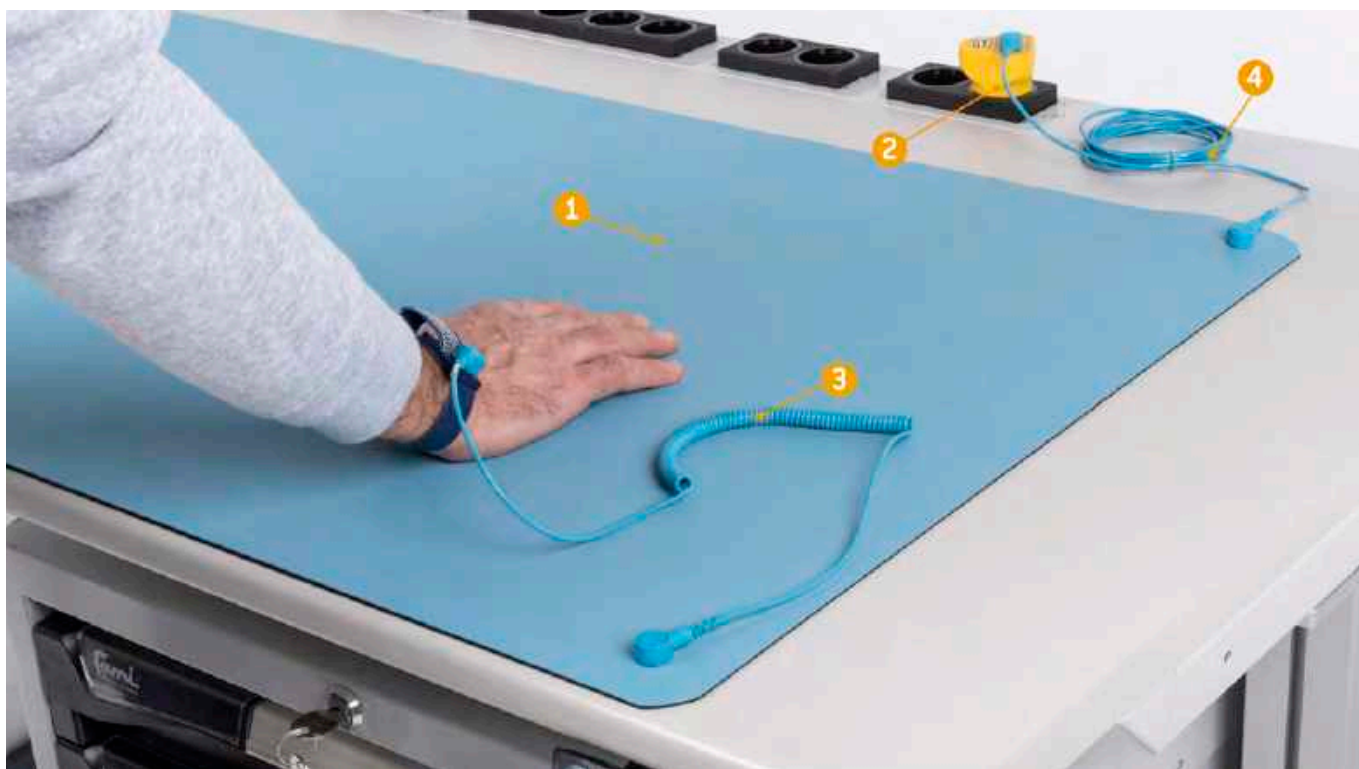

1. Tappeto ESD a 2 strati
2. Spina schuko ESD
3. Cinturino regolabile con bottoni completo di cavetto
4. Cavetto con bottoni

TAPPETO ESDA 2 STRATI

ART.	Lmm	Pmm	Hmm	€
FAXTAPPIER120XB	900	600	2	99,00

SPINA SCHUKO ESD

ART.	Lmm	Pmm	Hmm	€
FAXSCHUKOESD005	52	52	72	22,50

CINTURINO REGOLABILE CON BOTTONI COMPLETO DI CAVETTO

ART.	Lcavom	€
FAXITE780419304	2,5	7,80

CAVETTO CON BOTTONI

ART.	Lmm	€
FAXITE7804885XB	2500	6,00



RAL 7035



RAL 7035 + RAL 7016



ESTRAZIONE



PORTATA

WORK LOOK

PARETI ATTREZZATE

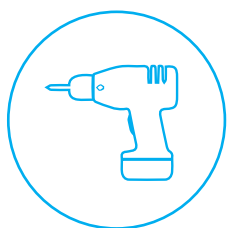
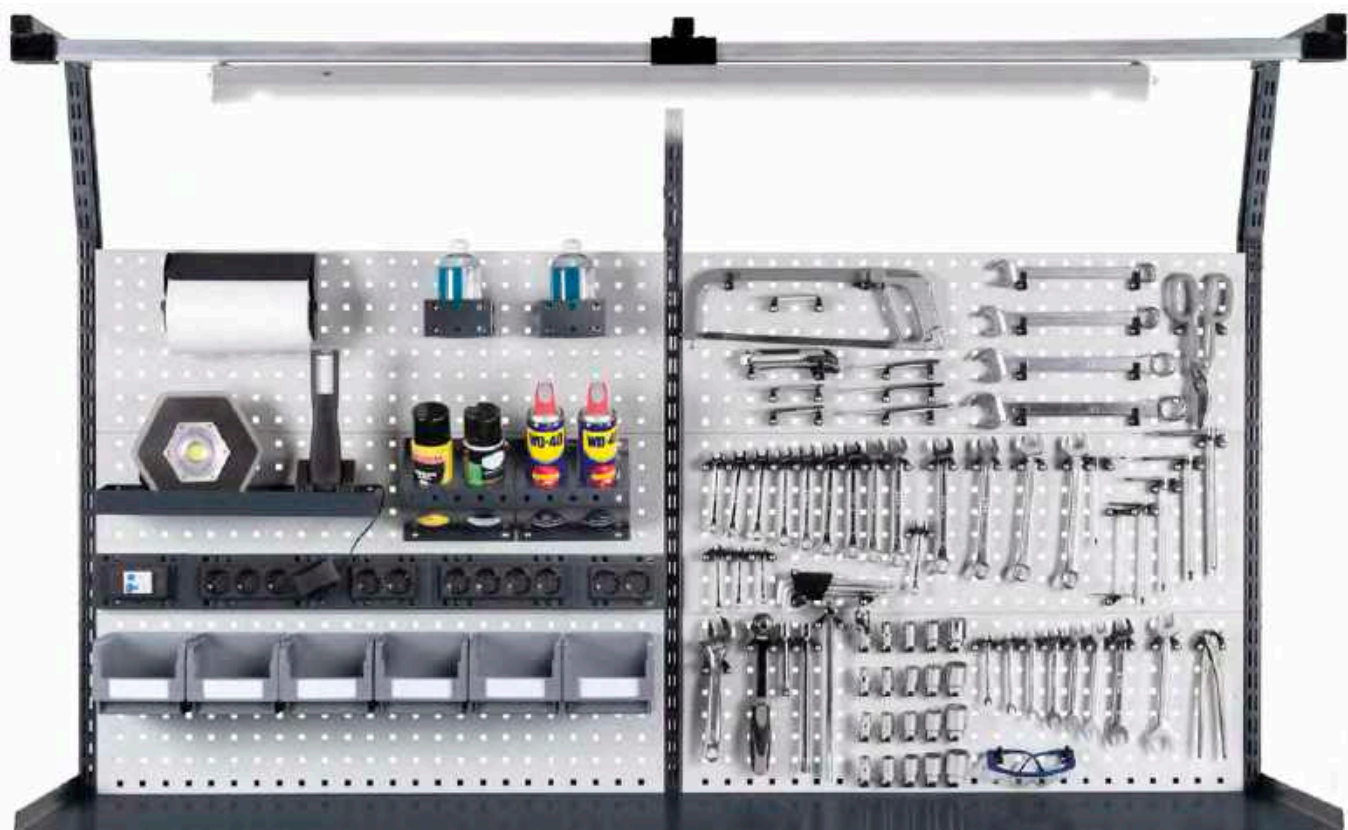

FISSAGGIO A MURO

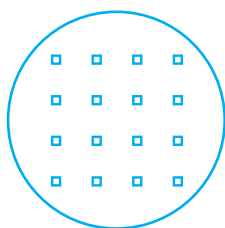

FORI QUADRI 10X10

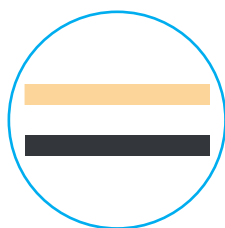

ADATTE PER PIANI IN
LEGNO E ACCIAIO

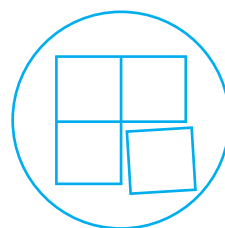

MODULARI

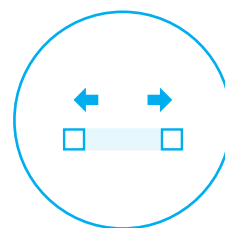

PASSO 38 MM

WORK LOOK



ART.	Lmm	Pmm	Hmm	KG	RAL	€
MASTERBR1507	1706	750	1985/2360	1000	7035+7016	2196,00

Composto da:

qtà	descrizione
1	Banco smontato con piano in multiplex 40 mm
1	Armadio L=560 mm con 5 cassetti 1x75 3x100 1x200
2	Piano superiore/inferiore L=560 mm
1	Porta totale sinistra H=600 mm con maniglia Dark Grey
1	Piano interno L=558 mm
1	Supporto semipiano intermedio
2	Pannello forato laterale
1	Barra led sotto pensile
1	Coppia staffe di fissaggio pensile su montanti
1	Pensile vasistas senza serratura
1	Lampada doppia
1	Kit 2 pannelli forati/mensole con 1 bordo fermacasse
1	Kit 2 supporti inclinati con binario

qtà	descrizione
1	Kit 2 montanti biasolati
1	Cestino capacità 30 L
1	Mensola grande reversibile
1	Barra aggancio con 4 contenitori Picking Box misura 1
3	Gancio Unipok per utensili - confezione 30 pezzi
2	Porta bombolette inclinato a 2 posti
1	Kit porta rotolo con carta Ø=130 mm
1	Tasca porta documenti A4
1	Cavo di collegamento wieland schuko/francese
1	Multipresa schuko a 4 scomparti
1	Multipresa schuko a 2 scomparti
1	Supporto multipresa a 4 scomparti
1	Supporto multipresa a 2 scomparti
1	Kit 2 contenitori Picking Box misura 3A2



PORTATA



RAL 7035 + RAL 7016

WORK LOOK

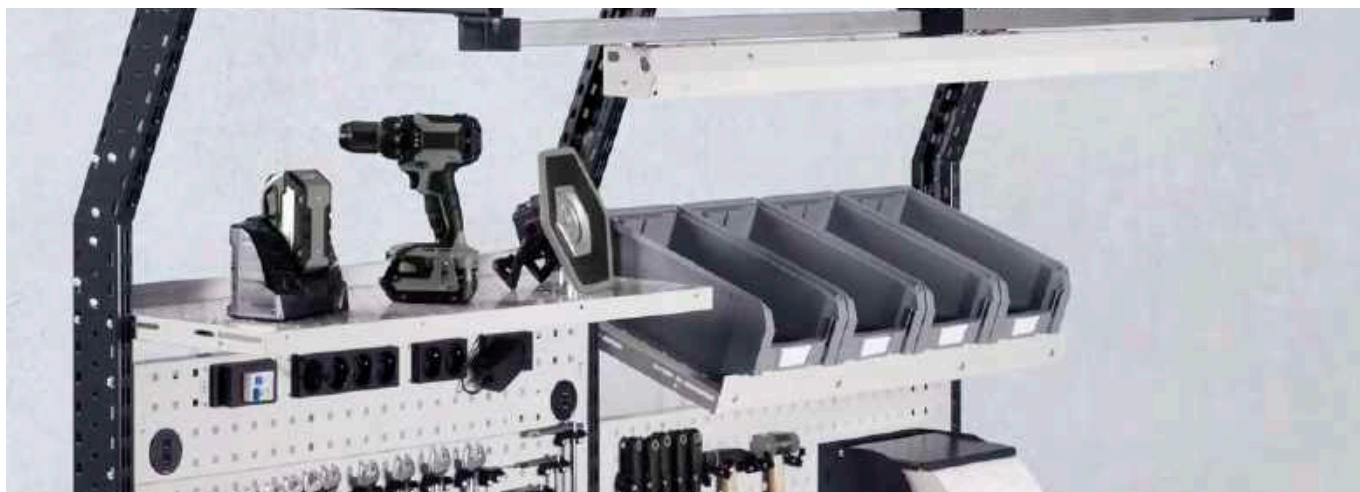

CAMBIA L'ASPETTO DEL TUO BANCO DA LAVORO PER ADATTARLO A DIVERSI UTILIZZI CON WORK LOOK!

In base a come lo installi lo puoi utilizzare come:
pannello forato, mensola orizzontale, mensola inclinata con bordo fermacasse.



ART.	Lmm	Pmm	Hmm	KG montanti	RAL	€
WORKLOOK1001	1015	80	634	50	7035+7016	108,00
WORKLOOK1002	1015	80	634	50	5012	108,00

Composto da:

qtà	descrizione
1	Kit 2 montanti biasolati
1	Kit 2 pannelli forati/mensole con 1 bordo fermacasse



ART.	Lmm	Pmm	Hmm	KG montanti	RAL	€
WORKLOOK1003	1015	80	938	50	7035+7016	151,50
WORKLOOK1004	1015	80	938	50	5012	151,50

Composto da:

qtà	descrizione
1	Kit 2 montanti biasolati
1	Kit 3 pannelli forati/mensole con 2 bordi fermacasse



ART.	Lmm	Pmm	Hmm	KG montanti	RAL	€
WORKLOOK1501	1500	80	634	50	7035+7016	142,50
WORKLOOK1502	1500	80	634	50	5012	142,50

Composto da:

qtà	descrizione
1	Kit 2 montanti biasolati
1	Kit 2 pannelli forati/mensole con 1 bordo fermacasse



ART.	Lmm	Pmm	Hmm	KG montanti	RAL	€
WORKLOOK1503	1500	80	938	50	7035+7016	204,00
WORKLOOK1504	1500	80	938	50	5012	204,00

Composto da:

qtà	descrizione
1	Kit 2 montanti biasolati
1	Kit 3 pannelli forati/mensole con 2 bordi fermacasse

WORK LOOK



ART.	Lmm	Pmm	Hmm	KG montanti	RAL	€
WORKLOOK2001	2000	80	634	50	7035+7016	198,00
WORKLOOK2002	2000	80	634	50	5012	198,00

Composto da:

qtà	descrizione
1	Kit 3 montanti biasolati
2	Kit 2 pannelli forati/mensole con 1 bordo fermacasse



ART.	Lmm	Pmm	Hmm	KG montanti	RAL	€
WORKLOOK2003	2000	80	938	50	7035+7016	280,50
WORKLOOK2004	2000	80	938	50	5012	280,50

Composto da:

qtà	descrizione
1	Kit 3 montanti biasolati
2	Kit 3 pannelli forati/mensole con 2 bordi fermacasse



ART.	Lmm	Pmm	Hmm	KG montanti	RAL	€
WORKLOOK3001	2970	80	634	50	7035+7016	267,00
WORKLOOK3002	2970	80	634	50	5012	267,00

Composto da:

qtà	descrizione
1	Kit 3 montanti biasolati
2	Kit 2 pannelli forati/mensole con 1 bordo fermacasse



ART.	Lmm	Pmm	Hmm	KG montanti	RAL	€
WORKLOOK3003	2970	80	938	50	7035+7016	385,50
WORKLOOK3004	2970	80	938	50	5012	385,50

Composto da:

qtà	descrizione
1	Kit 3 montanti biasolati
2	Kit 3 pannelli forati/mensole con 2 bordi fermacasse

ESEMPI DI CONFIGURAZIONE



PORTATA



RAL 7035 + RAL 7016



RAL 5012

WORK LOOK



ART.	L mm	P mm	H mm	KG montanti	RAL	€
WORKLOOK1005	1015	373	1063	50	7035+7016	429,00
WORKLOOK1006	1015	373	1063	50	5012	429,00

Composto da:

qtà	descrizione
1	Kit 2 montanti biasolati
1	Kit 2 pannelli forati/mensole con 1 bordo fermacasse
1	Pensile vasistas senza serratura
1	Coppia staffe di fissaggio pensile su montanti



ART.	L mm	P mm	H mm	KG montanti	RAL	€
WORKLOOK1007	1015	373	1063	50	7035+7016	490,50
WORKLOOK1008	1015	373	1063	50	5012	490,50

Composto da:

qtà	descrizione
1	Kit 2 montanti biasolati
1	Pannello forato/mensola con 1 bordo fermacasse
1	Pannello forato electric
1	Pensile vasistas senza serratura
1	Coppia staffe di fissaggio pensile su montanti
1	Multipresa schuko a 4 scomparti
1	Cavo di collegamento wieland schuko/francese



ART.	L mm	P mm	H mm	KG montanti	RAL	€
WORKLOOK1505	1500	373	1063	50	7035+7016	490,50
WORKLOOK1506	1500	373	1063	50	5012	490,50

Composto da:

qtà	descrizione
1	Kit 2 montanti biasolati
1	Kit 2 pannelli forati/mensole con 1 bordo fermacasse
1	Pensile vasistas senza serratura
1	Coppia staffe di fissaggio pensile su montanti



ART.	L mm	P mm	H mm	KG montanti	RAL	€
WORKLOOK1507	1500	373	1063	50	7035+7016	549,00
WORKLOOK1508	1500	373	1063	50	5012	549,00

Composto da:

qtà	descrizione
1	Kit 2 montanti biasolati
1	Pannello forato/mensola con 1 bordo fermacasse
1	Pannello forato electric
1	Pensile vasistas senza serratura
1	Coppia staffe di fissaggio pensile su montanti
1	Multipresa schuko a 4 scomparti
1	Cavo di collegamento wieland schuko/francese



WORK LOOK



ART.	L mm	P mm	H mm	KG montanti	RAL	€
WORKLOOK2005	2000	373	1063	50	7035+7016	835,50
WORKLOOK2006	2000	373	1063	50	5012	835,50

Composto da:

qtà	descrizione
1	Kit 3 montanti biasolati
2	Kit 2 pannelli forati/mensole con 1 bordo fermacasse
2	Pensile vasistas senza serratura
2	Coppia staffe di fissaggio pensile su montanti

ART.	L mm	P mm	H mm	KG montanti	RAL	€
WORKLOOK2007	2000	373	1063	50	7035+7016	960,00
WORKLOOK2008	2000	373	1063	50	5012	960,00

Composto da:

qtà	descrizione
1	Kit 3 montanti biasolati
2	Pannello forato/mensola con 1 bordo fermacasse
2	Pannello forato electric
2	Pensile vasistas senza serratura
2	Coppia staffe di fissaggio pensile su montanti
2	Multipresa schuko a 4 scomparti
1	Cavo di collegamento wieland con spine in/out
1	Cavo di collegamento wieland schuko/francese



ART.	L mm	P mm	H mm	KG montanti	RAL	€
WORKLOOK3005	2970	373	1063	50	7035+7016	958,50
WORKLOOK3006	2970	373	1063	50	5012	958,50

Composto da:

qtà	descrizione
1	Kit 3 montanti biasolati
2	Kit 2 pannelli forati/mensole con 1 bordo fermacasse
2	Pensile vasistas senza serratura
2	Coppia staffe di fissaggio pensile su montanti

ART.	L mm	P mm	H mm	KG montanti	RAL	€
WORKLOOK3007	2970	373	1063	50	7035+7016	1077,00
WORKLOOK3008	2970	373	1063	50	5012	1077,00

Composto da:

qtà	descrizione
1	Kit 3 montanti biasolati
2	Pannello forato/mensola con 1 bordo fermacasse
2	Pannello forato electric
2	Pensile vasistas senza serratura
2	Coppia staffe di fissaggio pensile su montanti
2	Multipresa schuko a 4 scomparti
1	Cavo di collegamento wieland con spine in/out
1	Cavo di collegamento wieland schuko/francese



ESEMPI DI CONFIGURAZIONE



PORTATA



RAL 7035 + RAL 7016



RAL 5012

WORK LOOK

MONTANTI



KIT 2 MONTANTI BIASOLATI

ART.	Lmm	Pmm	Hmm	KG	adatto per banco Lmm	RAL	€
FBL75301604	30	80	637	50	1000-1500	5012	37,50
FBL75301639	30	80	637	50	1000-1500	7016	37,50
FBL75351604	30	80	941	50	1000-1500	5012	45,00
FBL75351639	30	80	941	50	1000-1500	7016	45,00

KIT 3 MONTANTI BIASOLATI

ART.	Lmm	Pmm	Hmm	KG	adatto per banco Lmm	RAL	€
FBL75302104	30	80	637	50	2000-3000	5012	57,00
FBL75302139	30	80	637	50	2000-3000	7016	57,00
FBL75352104	30	80	941	50	2000-3000	5012	67,50
FBL75352139	30	80	941	50	2000-3000	7016	67,50

WORK LOOK

SUPPORTI INCLINATI CON BINARIO BASE



KIT 2 SUPPORTI INCLINATI CON BINARIO

ART.	Lmm	Pmm	Hmm	RAL	€
FBL98102039	1015	686	307	7016	84,00
FBL98102004	1015	686	307	5012	72,00



KIT 2 SUPPORTI INCLINATI CON BINARIO

ART.	Lmm	Pmm	Hmm	RAL	€
FBL98152039	1500	686	307	7016	87,00
FBL98152004	1500	686	307	5012	73,50



KIT 3 SUPPORTI INCLINATI CON 2 BINARI

ART.	Lmm	Pmm	Hmm	RAL	€
FBL98202039	2000	686	307	7016	132,00
FBL98202004	2000	686	307	5012	111,00



KIT 3 SUPPORTI INCLINATI CON 2 BINARI

ART.	Lmm	Pmm	Hmm	RAL	€
FBL98302039	2970	686	307	7016	138,00
FBL98302004	2970	686	307	5012	120,00



BINARIO SUPPLEMENTARE CON ATTACCHI

ART.	Lmm	Pmm	Hmm	materiale	€
FBL98101000	1015	60	67	Alluminio	22,50
FBL98151000	1500	60	67	Alluminio	25,50

SET ARIA COMPRESSA CON BILANCIATORE E FILTRO

ART.	€
FBL97200300	379,50

Completo di:

- 1 cavo flessibile Ø 10 mm
- 1 connettore a T da 1/4" con tappo (B)
- 2 fermi
- 2 attacchi di scorrimento
- 1 moschettone
- 1 bilanciatore con cavo in acciaio lunghezza 1600 mm portata 1/2 kg
- 1 attacco universale 1/4" per utensili (A)
- 1 tubo a spirale diametro interno 5,5 mm
- 1 tubo diametro interno 5,5 mm per lo spurgo del filtro
- 1 gruppo filtro regolatore con manometro - il quale può essere utilizzato con una pressione massima di 10 bar, la sua capacità è di circa 9 litri al secondo (sul punto A) è di 11 litri al secondo (sul punto B) con una pressione di utilizzo pari a 6,3 bar (la capacità può variare a seconda delle caratteristiche tecniche della rete pneumatica a cui l'impianto Fami viene allacciato)
- raccordi da 1/4"



PORTATA



RAL 7016



RAL 5012

WORK LOOK

PANNELLI FORATI/MENSOLA 953 MM



PANNELLO FORATO/MENSOLA

ART.	Lmm	Pmm	Hmm	Dim. foro mm	Passo mm	RAL	€
FBL76160008	953	31	304	10x10	38	7035	31,50
FBL76160004	953	31	304	10x10	38	5012	31,50



KIT 2 PANNELLI FORATI/MENSOLE CON 1 BORDO FERMACASSE

ART.	Lmm	Pmm	Hmm	Dim. foro mm	Passo mm	RAL	€
FBL76160208	953	31	304	10x10	38	7035	70,50
FBL76160204	953	31	304	10x10	38	5012	70,50



KIT 3 PANNELLI FORATI/MENSOLE CON 2 BORDI FERMACASSE

ART.	Lmm	Pmm	Hmm	Dim. foro mm	Passo mm	RAL	€
FBL76160308	953	31	304	10x10	38	7035	106,50
FBL76160304	953	31	304	10x10	38	5012	106,50



PANNELLO FORATO/MENSOLA CON 1 BORDO FERMACASSE

ART.	Lmm	Pmm	Hmm	Dim. foro mm	Passo mm	RAL	€
FBL76170108	953	60	456	10x10	38	7035	55,50
FBL76170104	953	60	456	10x10	38	5012	55,50



PANNELLO FORATO ELECTRIC

ART.	Lmm	Pmm	Hmm	Dim. foro mm	Passo mm	RAL	€
FBL76180008	953	31	152	10x10	38	7035	33,00
FBL76180004	953	31	152	10x10	38	5012	33,00

1. USB Dati
2. Magnetotermico differenziale
3. Multipresa 4 scomparti
4. Multipresa 2 scomparti
5. USB Ricarica



WORK LOOK

PANNELLI FORATI/MENSOLA 1438 MM



PANNELLO FORATO/MENSOLA

ART.	Lmm	Pmm	Hmm	Dim. foro mm	Passo mm	RAL	€
FBL76310008	1438	31	304	10x10	38	7035	48,00
FBL76310004	1438	31	304	10x10	38	5012	48,00



KIT 2 PANNELLI FORATI/MENSOLE CON 1 BORDO FERMACASSE

ART.	Lmm	Pmm	Hmm	Dim. foro mm	Passo mm	RAL	€
FBL76310208	1438	31	304	10x10	38	7035	105,00
FBL76310204	1438	31	304	10x10	38	5012	105,00



KIT 3 PANNELLI FORATI/MENSOLE CON 2 BORDI FERMACASSE

ART.	Lmm	Pmm	Hmm	Dim. foro mm	Passo mm	RAL	€
FBL76310308	1438	31	304	10x10	38	7035	159,00
FBL76310304	1438	31	304	10x10	38	5012	159,00



PANNELLO FORATO/MENSOLA CON 1 BORDO FERMACASSE

ART.	Lmm	Pmm	Hmm	Dim. foro mm	Passo mm	RAL	€
FBL76320108	1438	60	456	10x10	38	7035	73,50
FBL76320104	1438	60	456	10x10	38	5012	73,50

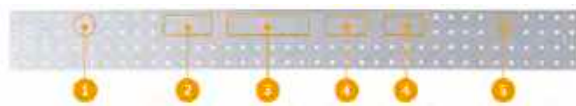

PANNELLO FORATO ELECTRIC

ART.	Lmm	Pmm	Hmm	Dim. foro mm	Passo mm	RAL	€
FBL76330008	1438	31	152	10x10	38	7035	46,50
FBL76330004	1438	31	152	10x10	38	5012	46,50

1. USB Dati
2. Magnetotermico differenziale
3. Multipresa 4 scomparti
4. Multipresa 2 scomparti
5. USB Ricarica



RAL 7035



RAL 5012

WORK LOOK



ART.	RAL	€
WORKLOOK9001	7035	1079,10



Composto da:

qtà	descrizione
2	Pannello forato/mensola con 1 bordo fermacasse
3	Pannello forato/mensola
5	Kit staffe per fissaggio pannelli a parete
1	Mensola porta oggetti reversibile
1	Porta flacone igienizzante reversibile
1	Kit porta rotolo con carta Ø=240 mm
1	Dispenser per guanti
1	Tasca porta documenti A4
2	Mensola grande reversibile

qtà	descrizione
1	Cestino capacità 30 L
5	Gancio Unipok per utensili - confezione 30 pezzi
1	Multipresa schuko a 2 scomparti
1	Multipresa schuko a 4 scomparti
1	Magnetotermico differenziale
1	Cavo di collegamento wieland schuko/francese
1	Supporto multipresa a 2 scomparti
1	Supporto multipresa a 4 scomparti
1	Supporto per magnetotermico differenziale
2	Lampada doppia

KIT STAFFE PER FISSAGGIO PANNELLI A PARETE

ART.	finitura	€
FBL76000099	Zincato	6,00



WORK LOOK

PENSILI



PENSILEVASISTAS SENZA SERRATURA

ART.	Lmm	Pmm	Hmm	 KG	RAL	€
FBL8005X000PD	943	350	456	50	7035+7016	291,00
FBL8005X00004	943	350	456	50	5012	291,00
FBL8010X000PD	1428	350	456	50	7035+7016	318,00
FBL8010X00004	1428	350	456	50	5012	318,00

SET DI CHIUSURA PER PENSILE

ART.	€
FBL8020C00000	9,60



COPPIA STAFFE DI FISSAGGIO PENSILE SU MONTANTI

ART.	Lmm	Pmm	Hmm	RAL	€
FBL8025000008	33	21	455	7035	22,50
FBL8025000004	33	21	455	5012	22,50

 Da utilizzare per il fissaggio del pensile ai montanti biasolati



BARRA LED SOTTO PENSILE

Senza pulsante on/off

ART.	Lmm	temperatura colore K	Watt	Hz	Lumen	€
FBL99400213	873	4000	15	50/60	1500	35,10
FBL99450213	1173	4000	20	50/60	2000	37,50



PORTATA



RAL 7035 + RAL 7016



RAL 5012



RAL 7035

WORK LOOK

FISSAGGIO A PARETE

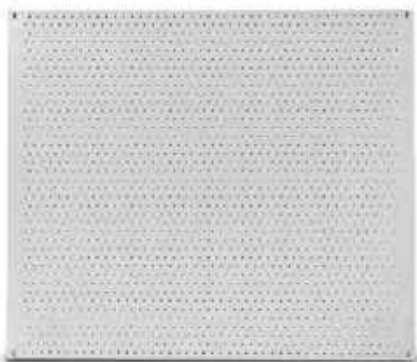

PANNELLO A FORO TONDO PORTAATTREZZI

ART.	Lmm	Pmm	Hmm	Ø foro mm	Passomm	RAL	€
FBG39100008	1003	15	850	4	21	7035	75,00
FBG39100004	1003	15	850	4	21	5012	75,00
FBG39150008	1503	15	850	4	21	7035	97,80
FBG39150004	1503	15	850	4	21	5012	97,80
FBG39200008	2003	15	850	4	21	7035	126,00
FBG39200004	2003	15	850	4	21	5012	126,00



MENSOLA PER PANNELLO PORTAATTREZZI

ART.	Lmm	Pmm	Hmm	RAL	€
FBG39400008	1000	154	126	7035	22,50
FBG39400004	1000	154	126	5012	22,50
FBG39450008	1500	154	126	7035	25,50
FBG39450004	1500	154	126	5012	25,50
FBG39500008	2000	154	126	7035	30,00
FBG39500004	2000	154	126	5012	30,00



GANCIO CON OCCHIELLO PER PANNELLO FORO TONDO

ART.	Multiplo d'ordine	Lmm	Pmm	Hmm	Ø foro mm	Ø filo mm	Passo mm	finitura	€
FBG39700099	25	60	24	30	17	3,5	21	Zincato	0,60



GANCIO CON SOSTEGNO PER PANNELLO FORO TONDO

ART.	Multiplo d'ordine	Lmm	Pmm	Hmm	Ø filo mm	Passo mm	finitura	€
FBG39710099	25	60	24	30	3,5	21	Zincato	0,60



GANCIO CON SOSTEGNO PER PANNELLO FORO TONDO

ART.	Multiplo d'ordine	Lmm	Pmm	Hmm	Ø filo mm	Passo mm	finitura	€
FBG39720099	25	110	24	30	3,5	21	Zincato	0,60



GANCIO CON SOSTEGNO PER PANNELLO FORO TONDO

ART.	Multiplo d'ordine	Lmm	Pmm	Hmm	Ø filo mm	Passo mm	finitura	€
FBG39730099	25	150	24	30	3,5	21	Zincato	0,90

COMPONENTS



Guarda il video!

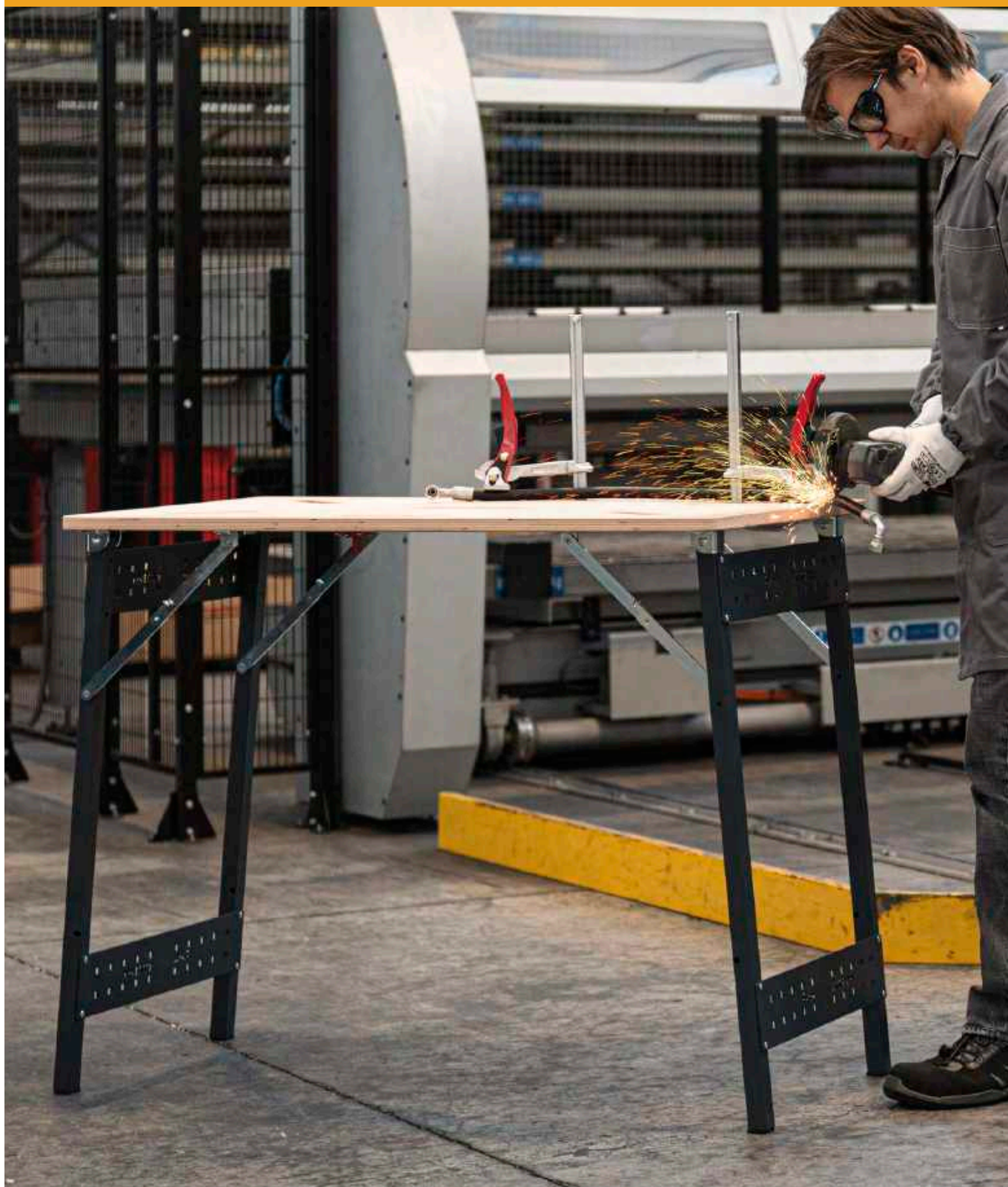

COMPONENTS



TAVOLO CON GAMBE PIEGHEVOLI

ART.	Dim. ingombro aperto			Dim. ingombro chiuso			materiale piano	KG	RAL	€
	Lmm	Pmm	Hmm	Lmm	Pmm	Hmm				
F22WWTABLE00039	1184	590	896	1100	590	60	Multiplex	400	7016	258,00



KIT 3 GANCI PER FISSAGGIO VERTICALE TAVOLO

ART.	Lmm	Pmm	Hmm	KG	RAL	€
F22WWTABLEFIS39	152	81	92	25	7016	28,20

KG
PORTATA

RAL 7016

COMPONENTS

SEDIE DA LAVORO



SEDIA REGOLABILE CON POMPA A GAS CON RUOTE

ART.	Lmm	Pmm	materiale	Hseduta mm	n. ruote	colore	€
FQZ22110007	600	600	Poliuretano	495/670	5	Nero	180,60



SEDIA REGOLABILE CON POMPA A GAS CON RUOTE

ART.	Lmm	Pmm	materiale	Hseduta mm	n. ruote	colore	€
FQZ12110007	600	600	Faggio	470/645	5	Nero	133,50



SEDIA REGOLABILE CON POMPA A GAS CON PIEDINI E POGGIAPIEDI

ART.	Lmm	Pmm	materiale	Hseduta mm	n. piedini	n. poggiapiedi	colore	€
FQZ22200007	600	600	Poliuretano	535/785	5	1	Nero	212,70

COMPONENTS

FAMICARES



TOTEM IGIENIZZANTE

ART.	L mm	P mm	H mm	Dim. foro mm	Passo mm	RAL	€
FBL76320208	650	377	1559	10x10	38	7035	144,00

IRONTEAM

vedi pag. 80



FBLIT002039



FBLIT005039



FBLIT003039



FBLIT001039



FBLIT015039



RAL 7035

ERGO WORK

BRACCI ESTENSIBILI

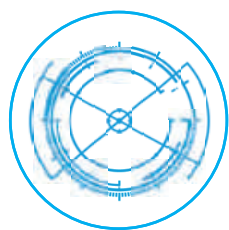

CONFIGURABILE

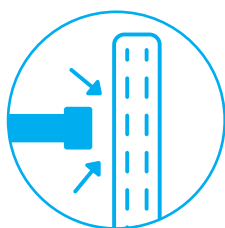

FISSAGGIO SU
MONTANTE

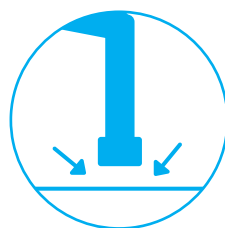

FISSAGGIO SU PIANO



PORTATA 20 KG

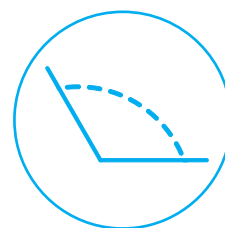

ANGOLO ROTAZIONE
240-260°

ERGO WORK



ART.	Lmm	Pmm	Hmm	KG	RAL	€
DYNAMIC1506	1497/3139	780	1983/2383	400	7035+7016	4070,40

Composto da:

qtà	descrizione
1	Banco smontato regolabile elettricamente
1	Armadio L=500 mm con 1 cassetto H=150 mm
1	Coperchio per armadio L=500 mm
1	Coppia supporti per armadio
1	Telaio portaprese aggiuntivo completo di tamponi e angolari
1	Kit 2 montanti biasolati
1	Kit 2 supporti inclinati con binario
1	Lampada doppia
1	Binario supplementare con attacchi
1	Set aria compressa con bilanciatore e filtro
2	Pannello forato/mensola con 1 bordo fermacasse
3	Lampada singola
1	Pannello forato/mensola
1	Pannello forato electric
2	Gancio Unipok per utensili - confezione 30 pezzi
1	Magnetotermico differenziale

qtà	descrizione
1	Multipresa schuko a 4 scomparti
2	Multipresa schuko a 2 scomparti
1	Presse usb ricarica
1	Presse usb dati
1	Cavo di collegamento wieland schuko/francese
1	Dispenser per guanti
1	Porta flacone igienizzante reversibile
36	Contenitore in polipropilene Picking Box misura 2
4	Braccio estensibile per montante
1	Snodo per piastra
3	Piastra porta monitor con standard VESA
1	Pannello per Picking Box
3	Barra aggancio con 4 contenitori Picking Box misura 1
1	Pannello per Visual Box
2	Cassettiera Visual Box con 6 cassette H=112 mm
1	Cassettiera Visual Box con 5 cassette H=164 mm
1	Vassoio inclinato



PORTATA



RAL 7035 + RAL 7016



RAL 7016



RAL 7035



BRACCIO ESTENSIBILE CON PICKING BOX

ART.	Lmm	Pmm	Hmm	RAL	€
ERGOWORK002	760/515	470/283	356	7016	174,00

Composto da:

qtà	descrizione
1	Braccio estensibile per montante
1	Piastra porta monitor con standard VESA
1	Pannello per Picking Box
3	Barra aggancio con 4 contenitori Picking Box misura 1



BRACCIO ESTENSIBILE CON PICKING BOX

ART.	Lmm	Pmm	Hmm	RAL	€
ERGOWORK003	826/515	470/348	356	7016	167,40

Composto da:

qtà	descrizione
1	Braccio estensibile per montante
1	Piastra porta monitor con standard VESA
1	Pannello per Picking Box
1	Barra aggancio con 3 contenitori Picking Box misura 2
1	Barra aggancio con 4 contenitori Picking Box misura 1



BRACCIO ESTENSIBILE CON VISUAL BOX

ART.	Lmm	Pmm	Hmm	RAL	€
ERGOWORK004	738/612	601/294	390	7016	217,80

Composto da:

qtà	descrizione
1	Braccio estensibile per montante
1	Piastra porta monitor con standard VESA
1	Pannello per Visual Box
1	Cassetteria Visual Box con 5 cassette H=164 mm
2	Cassetteria Visual Box con 6 cassette H=112 mm



PIASTRA PORTA MONITOR CON SQUADRETTE

ART.	Lmm	Pmm	Hmm	RAL	€
ERGOWORK014	225/129	119/225	225	7016	36,00

Composto da:

qtà	descrizione
1	Coppia squadrette a L
1	Snodo per piastra
1	Piastra porta monitor con standard VESA



PANNELLO FORATO CON CERNIERE

ART.	Lmm	Pmm	Hmm	RAL	€
ERGOWORK007	647	50	479	7035	61,80

Composto da:

qtà	descrizione
1	Pannello forato/mensola con 1 bordo fermacasse
1	Kit cerniere per pannello forato



BRACCIO ESTENSIBILE CON VASSOIO INCLINATO

ART.	Lmm	Pmm	Hmm	RAL	€
ERGOWORK005	674/522	425/470	194	7016	137,70

Composto da:

qtà	descrizione
1	Braccio estensibile per montante
1	Vassoio inclinato



BRACCIO ESTENSIBILE CON PIASTRA PORTA MONITOR

ART.	Lmm	Pmm	Hmm	RAL	€
ERGOWORK001	652/330	225/225	225	7016	121,50

Composto da:

qtà	descrizione
1	Braccio estensibile per montante
1	Snodo per piastra
1	Piastra porta monitor con standard VESA





RAL 7035

RAL 7016

ERGO WORK



ART.	Lmm	Pmm	Hmm	 senza ruote	 set ruote	RAL	€
CLEVER1031	1036	672	1428	300	300	7035	587,70

Composto da:

qtà	descrizione	qtà	descrizione
1	Carrello smontato senza ruote	1	Profilo con base per piano
1	Piano in legno con supporti	1	Coppia squadrette a L
2	Pannello laterale forato	1	Snodo per piastra
1	Pannello posteriore forato	1	Piastra porta monitor con standard VESA
1	Coppia porte a battente	1	Kit ruote in gomma antistriscia sintetica Ø 125 mm



BRACCIO ESTENSIBILE CON VASSOIO INCLINATO

ART.	Lmm	Pmm	Hmm	RAL	€
ERGOWORK013	745/521	425/480	552	7016	178,50

Composto da:

qtà	descrizione
1	Profilo con base per piano
1	Braccio estensibile per profilo
1	Vassoio inclinato

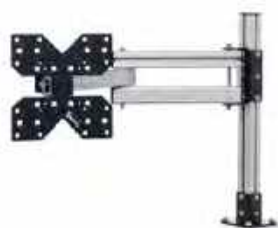

BRACCIO ESTENSIBILE CON PIASTRA PORTA MONITOR

ART.	Lmm	Pmm	Hmm	RAL	€
ERGOWORK009	724/402	225/192	550	7016	162,30

Composto da:

qtà	descrizione
1	Profilo con base per piano
1	Braccio estensibile per profilo
1	Snodo per piastra
1	Piastra porta monitor con standard VESA



PROFILO CON PIASTRA PORTA MONITOR

ART.	Lmm	Pmm	Hmm	RAL	€
ERGOWORK008	225/199	151/225	560	7016	73,80

Composto da:

qtà	descrizione
1	Profilo con base per piano
1	Coppia squadrette a L
1	Snodo per piastra
1	Piastra porta monitor con standard VESA



PORTATA



RAL 7016



RAL 7035



BRACCIO ESTENSIBILE CON PICKING BOX

ART.	L mm	P mm	H mm	RAL	€
ERGOWORK010	832/515	470/300	628	7016	214,80

Composto da:

qtà	descrizione
1	Profilo con base per piano
1	Braccio estensibile per profilo
1	Piastra porta monitor con standard VESA
1	Pannello per Picking Box
3	Barra aggancio con 4 contenitori Picking Box misura 1



BRACCIO ESTENSIBILE CON PICKING BOX

ART.	L mm	P mm	H mm	RAL	€
ERGOWORK011	898/515	470/365	628	7016	208,20

Composto da:

qtà	descrizione
1	Profilo con base per piano
1	Braccio estensibile per profilo
1	Piastra porta monitor con standard VESA
1	Pannello per Picking Box
1	Barra aggancio con 3 contenitori Picking Box misura 2
1	Barra aggancio con 4 contenitori Picking Box misura 1



BRACCIO ESTENSIBILE CON VISUAL BOX

ART.	L mm	P mm	H mm	RAL	€
ERGOWORK012	808/601	601/275	668	7016	258,60

Composto da:

qtà	descrizione
1	Profilo con base per piano
1	Braccio estensibile per profilo
1	Piastra porta monitor con standard VESA
1	Pannello per Visual Box
1	Cassettiera Visual Box con 5 cassette H=164 mm
2	Cassettiera Visual Box con 6 cassette H=112 mm

ERGO WORK



ART.	L mm	P mm	H mm	KG	RAL	€
MASTERBR2008	3347	750	1985/2360	1000	7035+7016	2602,80

Composto da:

qtà	descrizione
1	Banco smontato con piano in multiplex 40 mm
1	Copertura per piano in multiplex
1	Armadio L=560 mm con 4 cassetti 1x75 2x150 1x200
1	Armadio L=560 mm predisposto per porta con 1 piano regolabile
1	Porta totale sinistra H=600 mm con maniglia Dark Grey
2	Semipiano aggiuntivo L=560 mm
1	Kit 2 montanti biasolati
1	Kit 2 supporti inclinati con binario
1	Binario supplementare con attacchi
1	Lampada doppia
1	Kit 3 pannelli forati/mensole con 2 bordi fermacasse
1	Pannello forato electric
2	Multipresa schuko a 2 scomparti
1	Multipresa schuko a 4 scomparti

qtà	descrizione
1	Magnetotermico differenziale
1	Cavo di collegamento wieland schuko/francese
1	Porta flacone igienizzante reversibile
1	Dispenser per guanti
1	Kit porta rotolo con carta Ø=240 mm
4	Kit 2 contenitori Picking Box misura 3A2
2	Pannello forato/mensola con 1 bordo fermacasse
2	Kit cerniere per pannello forato
4	Barra aggancio con 4 contenitori Picking Box misura 1
4	Barra aggancio con 3 contenitori Picking Box misura 2
2	Profilo con base per piano
2	Braccio estensibile per profilo
1	Vassoio inclinato
1	Snodo per piastra
1	Piastra porta monitor con standard VESA



PORTATA



RAL 7035 + RAL 7016



RAL 7016



RAL 7035

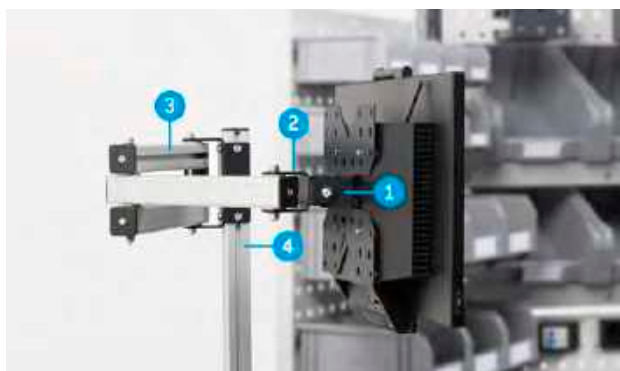

1. Piastra porta monitor con standard VESA
2. Snodo per piastra
3. Braccio estensibile per profilo
4. Profilo con base per piano



1. Piastra porta monitor con standard VESA
2. Pannello per Visual Box
3. Cassettiera Visual Box con 6 cassette H=112 mm
4. Braccio estensibile per montante



BRACCIO ESTENSIBILE PER MONTANTE

ART.	Lmm	Pmm	Hmm	angolo rotazione °	materiale	KG	RAL	€
FBL74100039	580/330	72/97	158	240	Alluminio	20	7016	95,10



BRACCIO ESTENSIBILE PER PROFILO

Da utilizzare su profilo con base per piano

ART.	Lmm	Pmm	Hmm	angolo rotazione °	materiale	KG	RAL	€
FBL74180039	621/371	57/90	158	260	Alluminio	20	7016	98,10



PROFILO CON BASE PER PIANO

ART.	Lmm	Pmm	Hmm	adatto per	materiale	KG	RAL	€
FBL74160039	100	100	504	Piano in multiplex- Piano in MDF con copertura gommata	Alluminio	20	7016	37,80



PANNELLO PER VISUAL BOX

Da utilizzare con piastra porta monitor

ART.	Lmm	Pmm	Hmm	Dim. foro mm	Passo mm	KG	RAL	€
FBL74150039	601	31	313	10x10	38	20	7016	52,20

vedi Visual Box pag. 190



PIASTRA PORTA MONITOR CON STANDARD VESA

Orientabile su un asse

ART.	L mm	P mm	H mm	RAL	€
FBL74120039	225	50	225	7016	12,60



SNODO PER PIASTRA

Da utilizzare con piastra porta monitor per orientarla su due assi

ART.	L mm	P mm	H mm	RAL	€
FBL74110039	91	67	51	7016	13,80



COPPIA SQUADRETTE AL

Da utilizzare con piastra porta monitor

ART.	L mm	P mm	H mm	RAL	€
FBL74170039	38	36	32	7016	9,60



VASSOIO INCLINATO

ART.	L mm	P mm	H mm	RAL	€
FBL74130039	425	308	135	7016	42,60

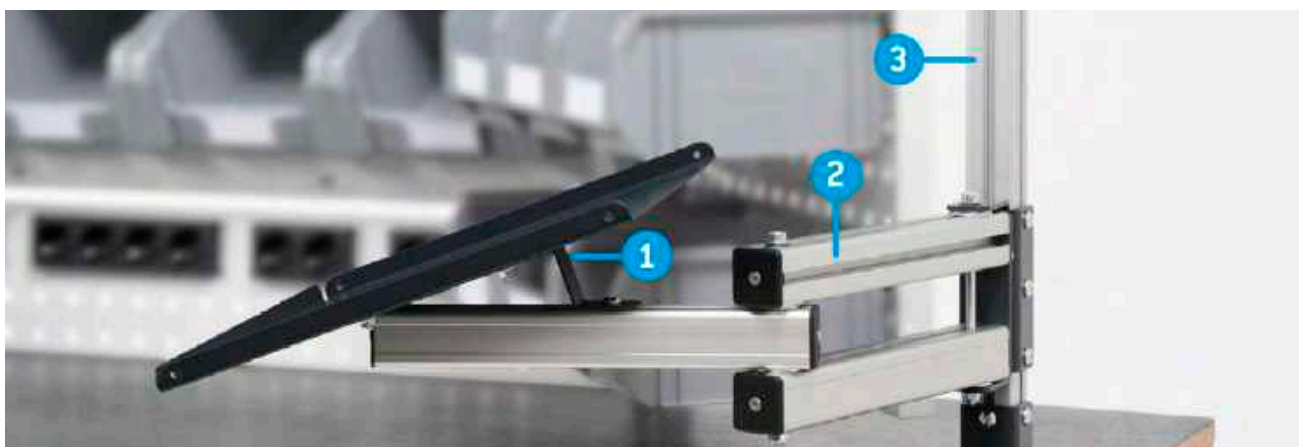

1. Vassoio inclinato
2. Braccio estensibile per profilo
3. Profilo con base per piano



PANNELLO PER PICKING BOX

Da utilizzare con piastra porta monitor

ART.	L mm	P mm	H mm	adatto per	 KG	RAL	€
FBL74140039	470	12	356	Contenitore Picking Box mis. 1/2	20	7016	38,40



BARRA AGGANCIO CON 4 CONTENITORI PICKING BOX MISURA 1

ART.	L mm	P mm	H mm	colore contenitori	€
FBLIT011000	445	168	85	Grigio scuro	9,30
FBLIT012000	445	168	85	Nero	15,00



BARRA AGGANCIO CON 3 CONTENITORI PICKING BOX MISURA 2

ART.	L mm	P mm	H mm	colore contenitori	€
FBLIT013000	447	233	123	Grigio scuro	12,00
FBLIT014000	447	233	123	Nero	21,00

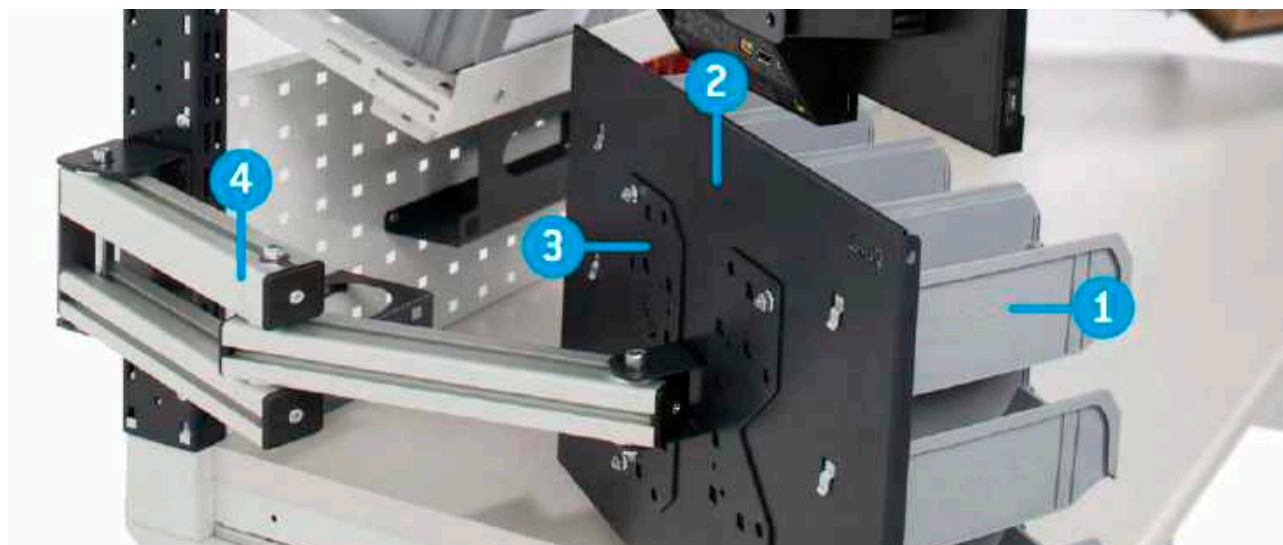

1. Barra aggancio con 4 contenitori Picking Box misura 1
2. Pannello per Picking Box
3. Piastra porta monitor con standard VESA
4. Braccio estensibile per montante



PANNELLO FORATO/MENSOLA

ART.	Lmm	Pmm	Hmm	Dim. foro mm	Passo mm	RAL	€
FBL76070008	647	30	304	10x10	38	7035	28,80
FBL76070004	647	30	304	10x10	38	5012	28,80



PANNELLO FORATO/MENSOLA CON 1 BORDO FERMACASSE

ART.	Lmm	Pmm	Hmm	Dim. foro mm	Passo mm	RAL	€
FBL76080108	647	60	456	10x10	38	7035	38,40
FBL76080104	647	60	456	10x10	38	5012	38,40



KIT CERNIERE PER PANNELLO FORATO

ART.	Lmm	Pmm	Hmm	RAL	€
FBL7600011F	64	54	21	9002	23,40

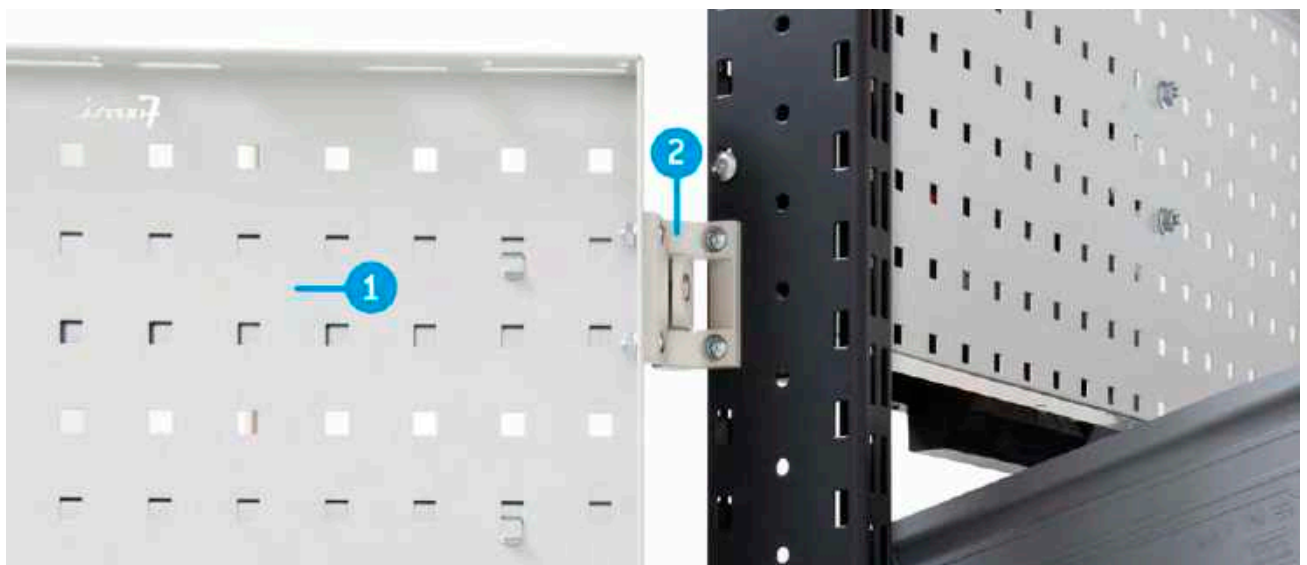

1. Pannello forato/mensola con 1 bordo fermacasse
2. Kit cerniere per pannello forato



PORTATA



RAL 5012



RAL 7016



RAL 7035



ART.	L mm	P mm	H mm	KG	RAL	€
MASTERBR1509	1706/3016	750	1985/2360	500	7035+7016	2559,90

Composto da:

qtà	descrizione	qtà	descrizione
1	Banco smontato con piano in multplex 40 mm	3	Braccio estensibile per montante
1	Armadio L=560 mm con 5 cassetti 1x75 3x100 1x200	1	Snodo per piastra
2	Piano superiore/inferiore L=560 mm	2	Piastra porta monitor con standard VESA
1	Porta totale sinistra H=600 mm con maniglia Dark Grey	1	Vassoio inclinato
1	Piano interno L=558 mm	1	Pannello per Visual Box
1	Supporto semipiano intermedio	1	Cassettiera Visual Box con 5 cassetti H=164 mm
2	Pannello forato laterale	2	Cassettiera Visual Box con 6 cassetti H=112 mm
1	Kit 2 montanti biasolati	1	Cestino capacità 30 L
1	Kit 2 pannelli forati/mensole con 1 bordo fermacasse	2	Porta bombolette inclinato a 2 posti
1	Kit 2 supporti inclinati con binario	1	Tasca porta documenti A4
1	Lampada doppia	1	Kit porta rotolo con carta Ø=130 mm
1	Pensile vasistas senza serratura	3	Gancio Unipok per utensili - confezione 30 pezzi
1	Barra led sotto pensile	1	Barra aggancio con 4 contenitori Picking Box misura 1
1	Coppia staffe di fissaggio pensile su montanti	1	Barra aggancio con 3 contenitori Picking Box misura 2

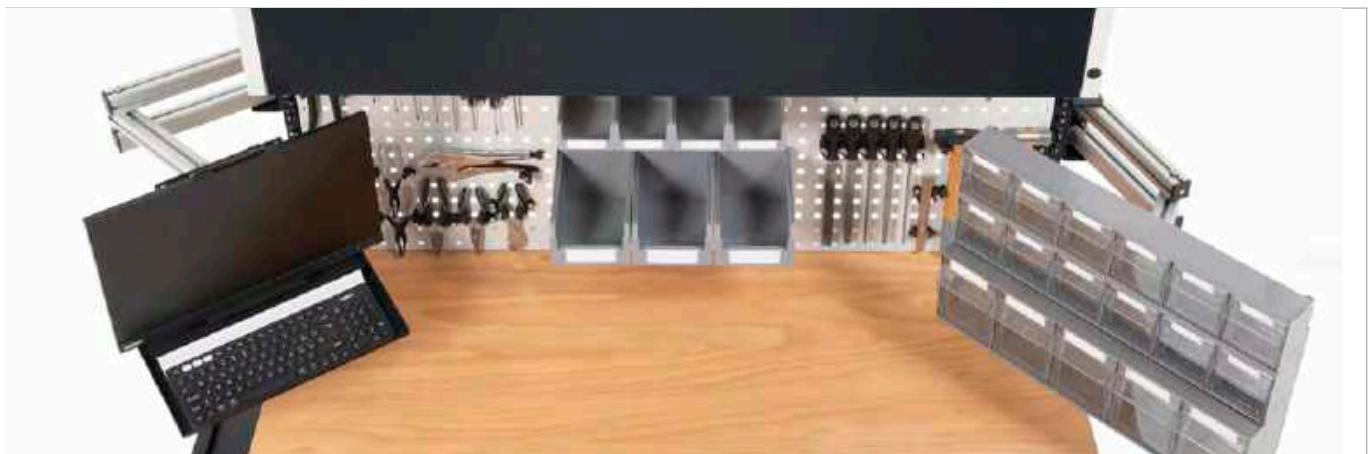

ERGO WORK



ART.	Lmm	Pmm	Hmm	KG	RAL	€
DYNAMIC1505	1497/1672	780	1983/2383	400	7035+7016	2550,60

Composto da:

qtà	descrizione
1	Banco smontato regolabile elettricamente
1	Armadio L=500 mm con 1 cassetto H=150 mm
1	Coperchio per armadio L=500 mm
1	Coppia supporti per armadio
1	Telaio portaprese aggiuntivo completo di tamponi e angolari
1	Kit 2 montanti biasolati
1	Coppia supporti per parete attrezzata L=1000 mm
1	Kit 2 supporti inclinati con binario
1	Lampada doppia
1	Kit 3 pannelli forati/mensole con 2 bordi fermacasse
1	Pannello forato electric
4	Kit 2 contenitori Picking Box misura 3A2

qtà	descrizione
1	Magnetotermico differenziale
1	Multipresa schuko a 4 scomparti
2	Multipresa schuko a 2 scomparti
1	Cavo di collegamento wieland schuko/francese
1	Coppia squadrette a L
1	Snodo per piastra
1	Piastra porta monitor con standard VESA
2	Pannello forato/mensola con 1 bordo fermacasse
2	Kit cerniere per pannello forato
2	Barra aggancio con 4 contenitori Picking Box misura 1
4	Barra aggancio con 3 contenitori Picking Box misura 2
2	Porta bombole inclinato a 2 posti



PORTATA



RAL 7035 + RAL 7016



Guarda il video!

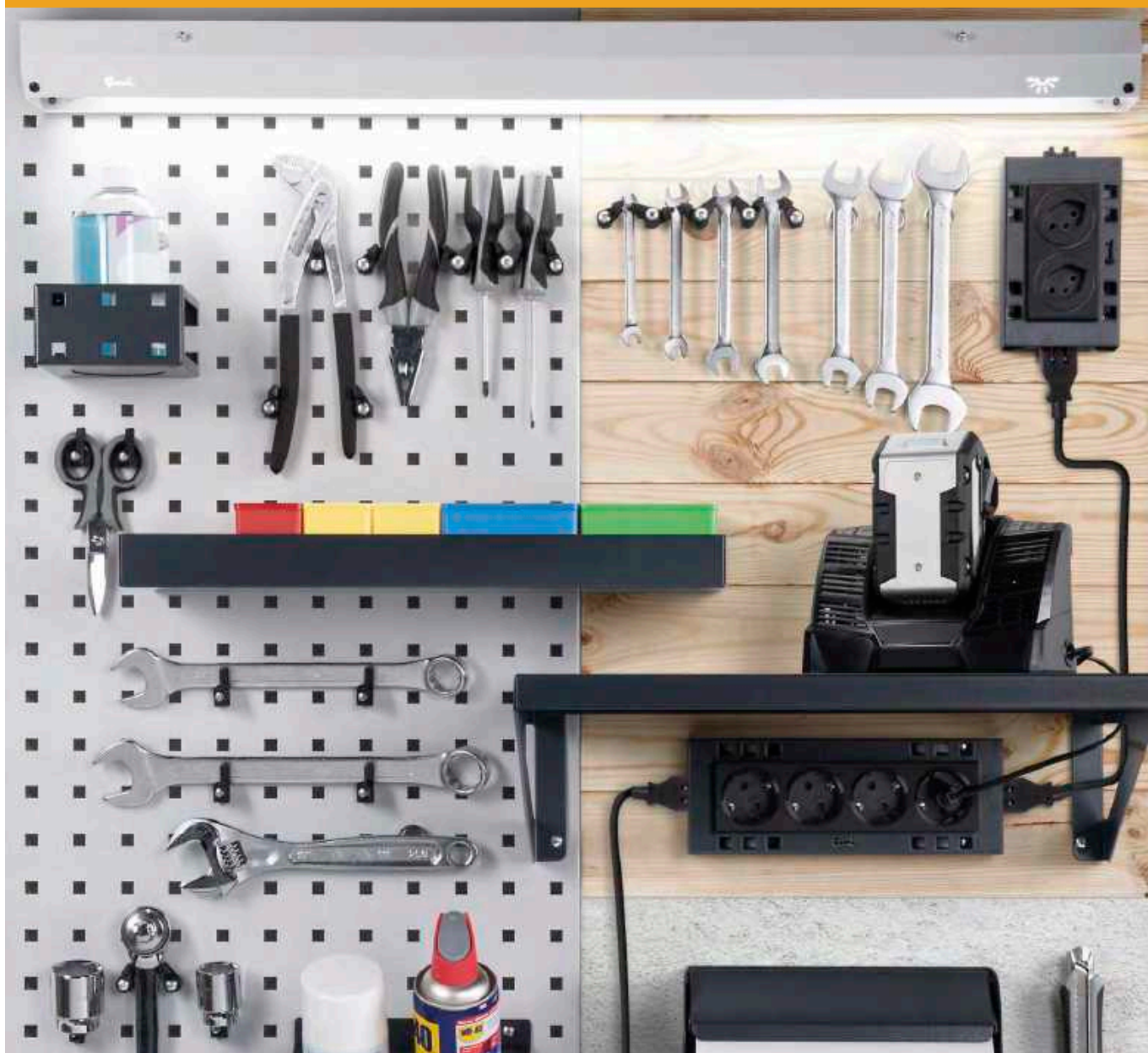

FISSAGGIO SU LEGNO



FISSAGGIO SU PANNELLO FORATO

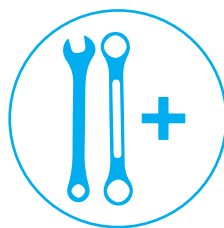

ADATTO PER TUTTI GLI UTENSILI



MOLTEPLICI POSIZIONI



GANCIO UNIPOK PER UTENSILI - CONFEZIONE 30 PEZZI

Con una confezione si possono agganciare fino a 30 utensili

ART.	pz. per confezione	colore	€
FBLIT009007	30	Nero	10,50

Unipok sono i **ganci universali** di Fami che, grazie al sistema a vite, possono essere posizionati su pareti forate o pannelli in legno. Ogni Unipok può essere posizionato con diverse inclinazioni per poter fissare utensili di volumi e dimensioni differenti. Libera la tua fantasia per organizzare al meglio la tua parete forata da muro o da banco e la tua parete in legno per avere sempre tutto a portata di mano!

Con Unipok l'ordine è un gioco da ragazzi!



Fissaggio su legno



Fissaggio su pannello forato

IN 4 POSIZIONI TUTTE LE COMBINAZIONI CHE VUOI!

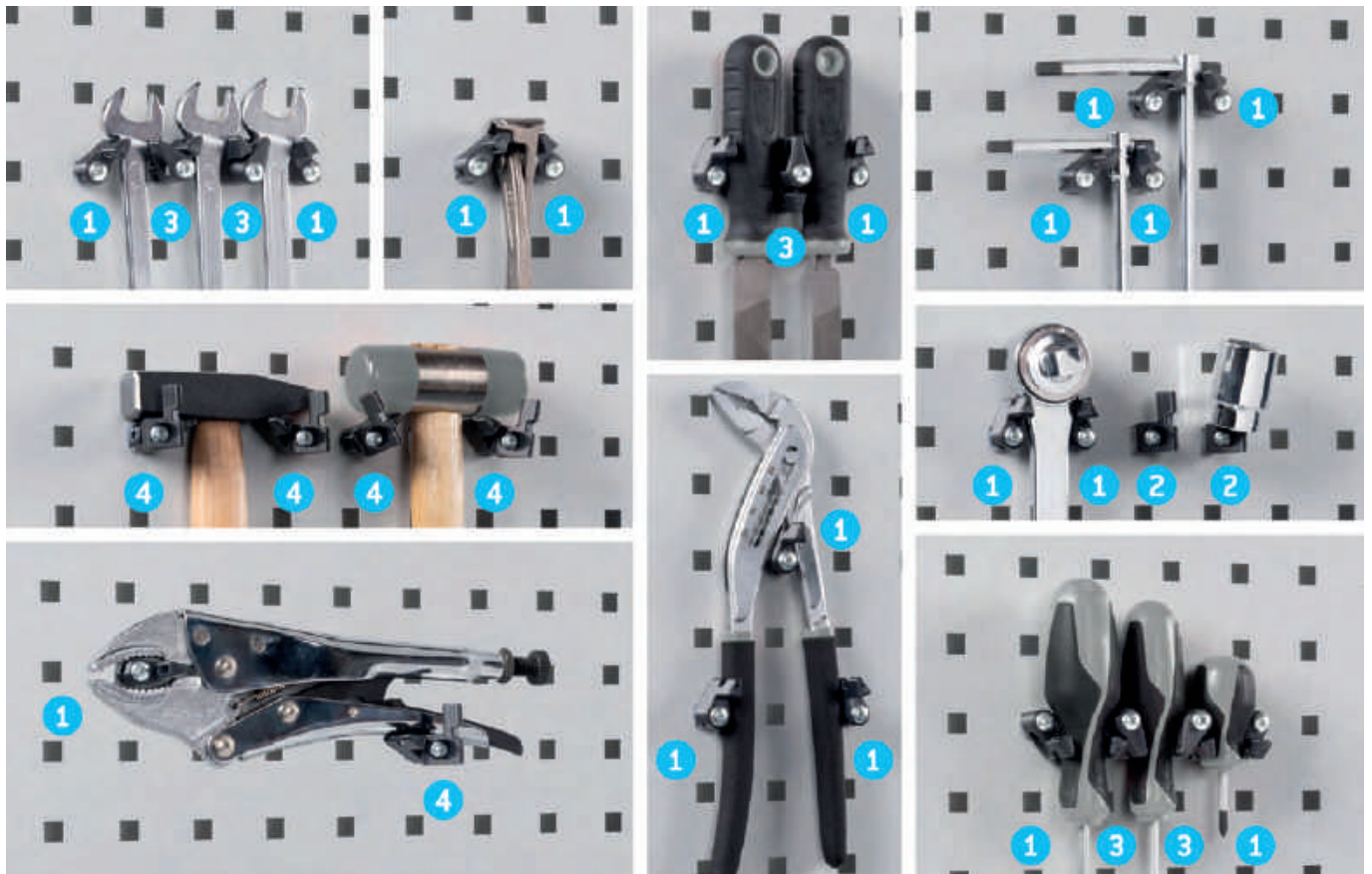

IRONTEAM

ACCESSORI UNIVERSALI



FISSAGGIO SU LEGNO



FISSAGGIO SU PANNELLO FORATO



FISSAGGIO SU MURO

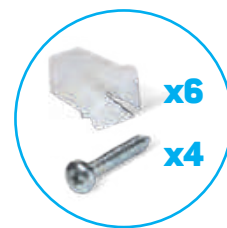

SET DI FISSAGGIO SU LEGNO E PANNELLO FORATO INCLUSO

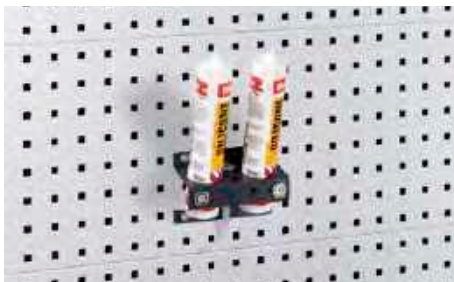

PORTA SILICONE INCLINATO A 2 POSTI

ART.	Lmm	Pmm	Hmm	Ø foro mm	RAL	€
FBLIT008039	150	71	96	61	7016	13,50



PORTA BOMBOLETTE INCLINATO A 2 POSTI

ART.	Lmm	Pmm	Hmm	Ø foro mm	RAL	€
FBLIT007039	188	111	172	70	7016	13,50



PORTA BOMBOLETTE A 6 POSTI

ART.	Lmm	Pmm	Hmm	RAL	€
FBLIT010039	455	75	167	7016	25,50



KIT PORTA CONTENITORE CON CONTENITORE SALVIETTE LAVAMANI

ART.	RAL	€
FBLIT006039	7016	81,00



KIT PORTA ROLOLO CON CARTA Ø=240 MM

ART.	Lmm	Pmm	Hmm	RAL	€
FBLIT004039	297	275	270	7016	49,80



KIT PORTA ROLOLO CON CARTA Ø=130 MM

ART.	Lmm	Pmm	Hmm	RAL	€
FBLIT003039	257	135	168	7016	30,90



PORTA FLACONE IGIENIZZANTE REVERSIBILE

ART.	Lmm	Pmm	Hmm	RAL	€
FBLIT002039	113	100	62	7016	15,00



DISPENSER PER GUANTI

ART.	Lmm	Pmm	Hmm	RAL	€
FBLIT005039	247	81	132	7016	12,00



CALAMITA COMPLETA DI CLIP E VITE - CONFEZIONE 10 PEZZI

ART.	pz. per confezione	Ø mm	finitura	€
FBL95410000	10	20	Zincato	42,00



GANCIO CURVO

ART.	multiplo d'ordine	Ø mm	L mm	P mm	H mm	finitura	€
CMV10001	10	5	43	20	45	Zincato	2,10



GANCIO ANGOLATO

ART.	multiplo d'ordine	Ø mm	L mm	P mm	H mm	finitura	€
CMV10016	10	5	40	50	45	Zincato	2,10



PORTA CACCIAVITI

ART.	multiplo d'ordine	Lmm	Pmm	Hmm	finitura	€
CMV10022	10	35	38	45	Zincato	1,80



GANCIO SEMPLICE

ART.	multiplo d'ordine	Ø mm	L mm	P mm	H mm	finitura	€
CMV10036	10	6	35	50	55	Zincato	1,80



PENSILE CON PORTA

ART.	Lmm	Pmm	Hmm	KG	RAL	€
FBL8015C000PD	460	250	456	25	7035+7016	99,00
FBL8015C00004	460	250	456	25	5012	96,00

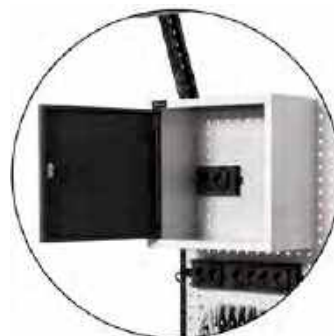

Esempio di applicazione del pensile su pannello Work Look con prese elettriche Iron Team. Il pensile viene fornito senza chiusura posteriore.



BARRAAGGANCI CON 4 CONTENITORI PICKING BOX MISURA 1

ART.	Lmm	Pmm	Hmm	colore contenitori	€
FBLIT011000	445	168	85	Grigio scuro	9,30
FBLIT012000	445	168	85	Nero	15,00



BARRAAGGANCI CON 3 CONTENITORI PICKING BOX MISURA 2

ART.	Lmm	Pmm	Hmm	colore contenitori	€
FBLIT013000	447	233	123	Grigio scuro	12,00
FBLIT014000	447	233	123	Nero	21,00



BARRAAGGANCI PER CONTENITORI PICKING BOX MISURA 1/2

ART.	Lmm	Pmm	Hmm	finitura	€
FBLIT020099	445	9	85	Zincato	3,90



KIT PORTA CONTENITORE

ART.	Lcinghia mm	RAL	€
FBLIT018039	910	7016	31,50



TASCA PORTA DOCUMENTI A4

ART.	Lmm	Pmm	Hmm	RAL	€
FBLIT001039	365	68	187	7016	18,00



KIT PRONTO SOCCORSO

ART.	Lmm	Pmm	Hmm	€
FBLIT024000	256	90	190	27,90



PORTA ESTINTORE CON ESTINTORE DA 2 KG

ART.	Lmm	Pmm	Hmm	€
FBLIT023000	115	115	400	58,20



SELLA REGGICAVI

ART.	Lmm	Pmm	Hmm	RAL	€
FBLIT019039	220	95	101	7016	21,00





PIASTRA PORTA MONITOR CON SQUADRETTE

ART.	Lmm	Pmm	Hmm	RAL	€
ERGOWORK014	225/129	119/225	225	7016	36,00

Composto da:

qtà	descrizione
1	Coppia squadrette a L
1	Snodo per piastra
1	Piastra porta monitor con standard VESA



CESTINO CAPACITÀ 30 L

ART.	Lmm	Pmm	Hmm	L	RAL	€
FBLIT025039	387	277	394	30	7016	87,00



VALIGETTA CON CONTENITORI

ART.	Lmm	Pmm	Hmm	€
FBLIT022001	440	350	80	47,40

KIT PORTAVALIGETTA

ART.	RAL	€
FBLIT021039	7016	42,00



MENSOLA PICCOLA REVERSIBILE

ART.	Lmm	Pmm	Hmm	RAL	€
FBLIT017039	303	317	144	7016	21,00



MENSOLA GRANDE REVERSIBILE

ART.	Lmm	Pmm	Hmm	RAL	€
FBLIT016039	455	317	144	7016	22,50



KIT 2 CONTENITORI PICKING BOX MISURA 3A2

ART.	Lmm	Pmm	Hmm	colore	€
FBLIT027001	200	350	145	Grigio scuro	11,10



KIT 10 CONTENITORI

ART.	€
FBLIT028000	10,50



MENSOLA PORTA OGGETTI REVERSIBILE

ART.	Lmm	Pmm	Hmm	RAL	€
FBLIT015039	455	160	40	7016	21,00



PORTA PUNTE

ART.	Lmm	Pmm	Hmm	finitura	€
FBLIT0260ZZ	155	84	39	Inox	25,50

Il porta punte può essere utilizzato all'interno della mensola porta oggetti reversibile.





SUPPORTO PER MAGNETOTERMICO DIFFERENZIALE

ART.	Lmm	Pmm	Hmm	RAL	€
FBLET003039	159	32	92	7016	13,50



MAGNETOTERMICO DIFFERENZIALE

2P+T 16A, 30mA TYPEA

ART.	Lmm	Pmm	Hmm	colore	€
FBLET012007	159	59	90	Nero	140,70

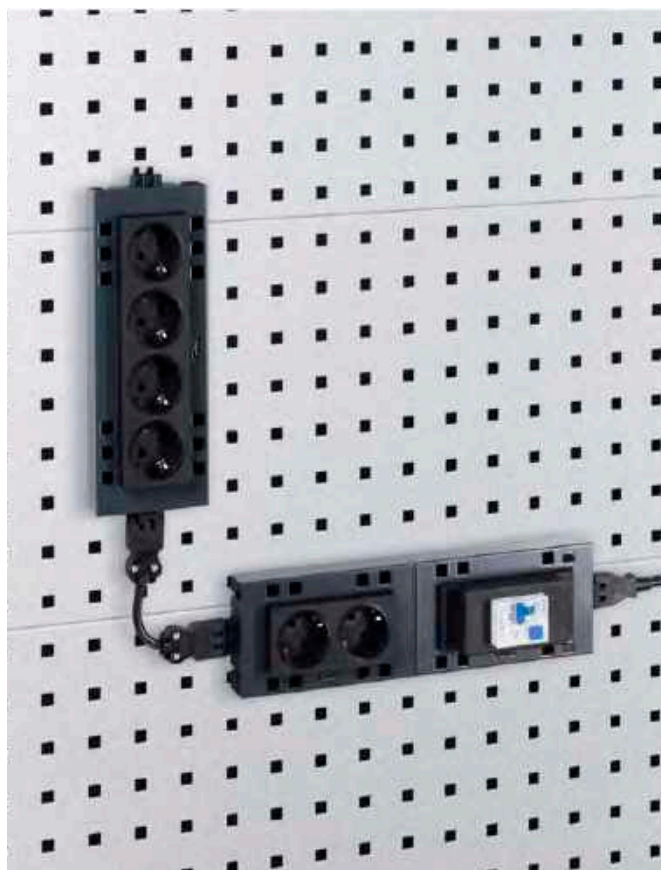

SUPPORTO MULTIPRESAA 2 SCOPARTI

ART.	Lmm	Pmm	Hmm	RAL	€
FBLET001039	148	32	92	7016	13,50



SUPPORTO MULTIPRESAA 4 SCOPARTI

ART.	Lmm	Pmm	Hmm	RAL	€
FBLET002039	249	32	92	7016	15,00



MULTIPRESAA 2 SCOPARTI

ART.	Lmm	Pmm	Hmm	tipo presa	colore	€
FBLET004007	148	59	46	Schuko	Nero	19,50
FBLET006007	148	59	46	Svizzera	Nero	40,50
FBLET008007	148	59	46	Inglese	Nero	33,00
FBLET010007	148	59	46	Francese	Nero	19,50



MULTIPRESAA 4 SCOPARTI

ART.	Lmm	Pmm	Hmm	tipo presa	colore	€
FBLET005007	248	59	46	Schuko	Nero	25,50
FBLET007007	248	59	46	Svizzera	Nero	46,50
FBLET009007	248	59	46	Inglese	Nero	54,00
FBLET011007	248	59	46	Francese	Nero	25,50



CAVO DI COLLEGAMENTO WIELAND CON SPINE IN/OUT

ART.	Lmm	Pmm	Hmm	colore	€
FBLET013007	200	28	13	Nero	18,00



CAVO DI COLLEGAMENTO WIELAND

ART.	Lmm	Pmm	Hmm	tipospina	colore	€
FBLET016007	3000	50	50	Schuko/ Francese	Nero	18,00
FBLET017007	3000	50	50	Inglese	Nero	21,00
FBLET018007	3000	50	50	Svizzera	Nero	19,50



CONNETTORE ADH WIELANDA 2 OUTPUT

ART.	Lmm	Pmm	Hmm	colore	€
FBLET015007	60	35	35	Nero	18,00



CAVO DI COLLEGAMENTO WIELAND CON SPINE IN/OUT

ART.	Lmm	Pmm	Hmm	colore	€
FBLET014007	1500	28	13	Nero	19,50





PRESAUSB DATI

ART.	Ø mm	Lmm	Hmm	colore	€
FBLET019007	59	70	54	Nero	126,00

PRESAUSB RICARICA

ART.	Ø mm	Lmm	Hmm	colore	€
FBLET020007	59	70	54	Nero	103,50





LAMPADA SINGOLA

Senza pulsante on/off

ART.	Lmm	temperatura colore K	Watt	Hz	Lumen	RAL	€
FBL99400008	955	4000	15	50/60	1500	7035	97,20
FBL99450008	1440	4000	20	50/60	2000	7035	106,50



LAMPADA DOPPIA

Senza pulsante on/off

ART.	Lmm	temperatura colore K	Watt	Hz	Lumen	RAL	€
FBL99400108	955	4000	15	50/60	1500	7035	130,80
FBL99450108	1440	4000	20	50/60	2000	7035	142,50



Esempio di fissaggio al binario aereo



Esempio di fissaggio al pannello forato tramite staffe



Esempio di fissaggio con calamita

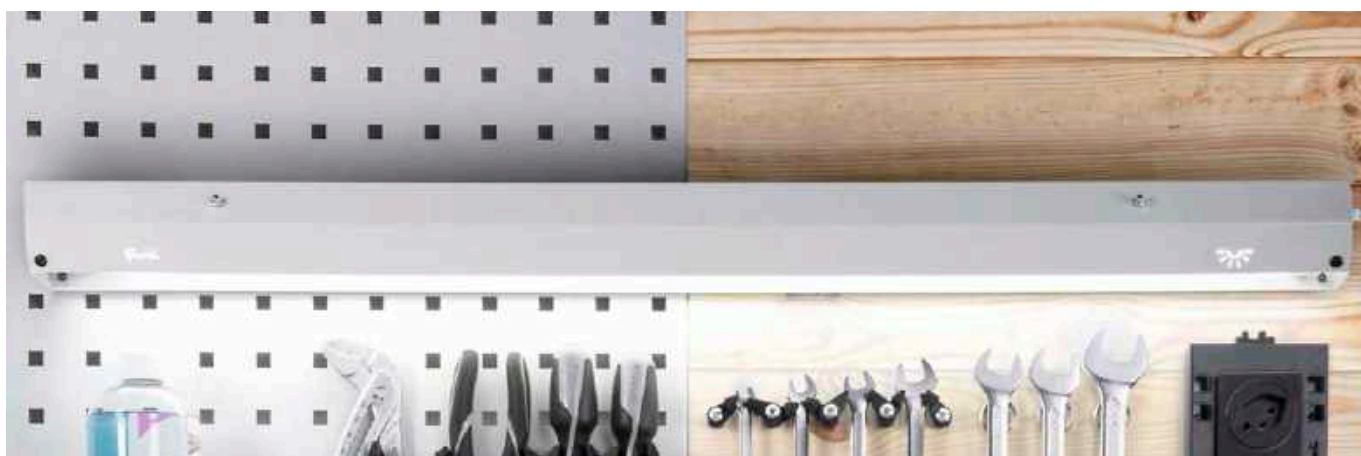

RAL 7035

MASTER DE - FLEXA

ARMADI CON CASSETTI



I cassetti degli armadi portautensili Fami presentano fondo forato e fessure laterali per personalizzare l'organizzazione interna del cassetto con il materiale di separazione.



PORTATA CASSETTI DA 50 A
100 KG

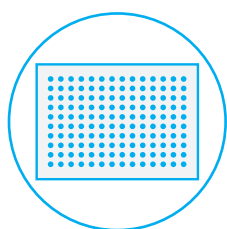

CASSETTI FORATI



CUSCINETTIA SFERA



CHIUSURA A CHIAVE

MASTER DE



Estrazione totale
100%



Portata fino a
100 kg



MANIGLIE PERSONALIZZABILI



UNA MINIERA DI INFORMAZIONI

Inserisci nella maniglia codici a barre, etichette o immagini per **conoscere** velocemente il **contenuto** di ogni singolo **cassetto**.

MAGGIOR CONO VISIVO



VISUALE COMPLETA

Estrazione e sagomatura dell'armadio ti consentono di **vedere completamente** l'interno dei cassetti più alti.

ESTRAZIONE TOTALE



LIBERTÀ NELLA CONFIGURAZIONE

Modifica velocemente e facilmente l'**estrazione** del cassetto per **aumentare la portata fino a 100 kg**.

GUIDE AD ALTE PRESTAZIONI



CORRERE SENZA PROBLEMI

Le guide lunghe come i cassetti permettono di spostare il **cuscinetto** nella parte **frontale** dell'armadio aumentando **visibilità, portata ed estrazione**.

CASSETTI FORATI



ORGANIZZAZIONE AL MILLIMETRO

Fori e scanalature sui cassetti facilitano la **suddivisione interna del cassetto per una perfetta organizzazione** di utensili e materiali.

FLEXA

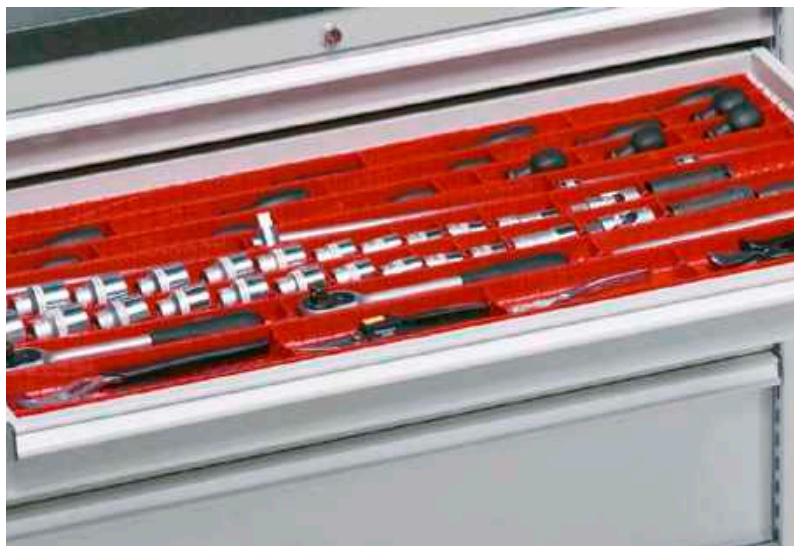

Estrazione totale
100%



Portata
70 kg



MASTER DE 36x36 EH

CASSETTIERA L=714 MM - CASSETTI AD ESTRAZIONE TOTALE



ART.	Lmm	Pmm	Hmm	cassetti									RAL	€
				n.	h 50 mm	h 75 mm	h 100 mm	h 150 mm	h 200 mm	h 300 mm	KG	↓		
D33A100C0100104	714	726	1000	6	-	-	-	6	-	-	100-75-50	92-96-100%	5012	780,60
D33A100C0100108	714	726	1000	6	-	-	-	6	-	-	100-75-50	92-96-100%	7035	780,60
D33A100C01001PD	714	726	1000	6	-	-	-	6	-	-	100-75-50	92-96-100%	7035+7016	819,00
D33A100C0100204	714	726	1000	7	1	2	2	-	1	1	100-75-50	92-96-100%	5012	837,30
D33A100C0100208	714	726	1000	7	1	2	2	-	1	1	100-75-50	92-96-100%	7035	837,30
D33A100C01002PD	714	726	1000	7	1	2	2	-	1	1	100-75-50	92-96-100%	7035+7016	897,60



ART.	Lmm	Pmm	Hmm	cassetti									RAL	€
				n.	h 50 mm	h 75 mm	h 100 mm	h 150 mm	h 200 mm	KG	↓			
D33A100C0100304	714	726	1000	8	1	2	2	2	1	100-75-50	92-96-100%	5012	903,90	
D33A100C0100308	714	726	1000	8	1	2	2	2	1	100-75-50	92-96-100%	7035	903,90	
D33A100C01003PD	714	726	1000	8	1	2	2	2	1	100-75-50	92-96-100%	7035+7016	967,50	
D33A100C0100404	714	726	1000	9	-	-	9	-	-	100-75-50	92-96-100%	5012	969,00	
D33A100C0100408	714	726	1000	9	-	-	9	-	-	100-75-50	92-96-100%	7035	968,70	
D33A100C01004PD	714	726	1000	9	-	-	9	-	-	100-75-50	92-96-100%	7035+7016	1039,20	

MASTER DE 36x36 EH COMPONENTI

MATERIALE DI SEPARAZIONE PER CASSETTIERA L=714 MM



TOPA 3 BORDI RIVESTITO IN PVC

ART.	Lmm	Pmm	Hmm	colore	€
M33T023AG003107	715	729	31	Nero	81,00

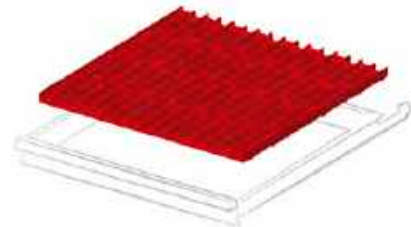
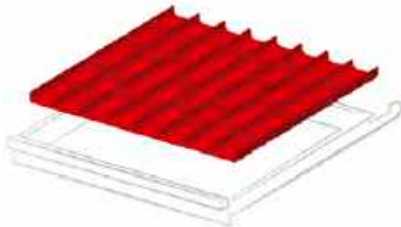

ART.	adatto per cassetto H mm	componenti	€
FFH20051500	50/300	35 x Divisorio trasversale L=73 mm 16 x Divisorio a 2 canali	30,60

ART.	adatto per cassetto H mm	componenti	€
FFH20051600	50/300	50 x Divisorio trasversale L=47 mm 16 x Divisorio a 3 canali	33,00

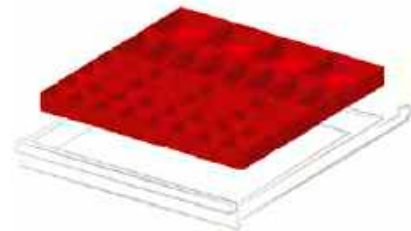
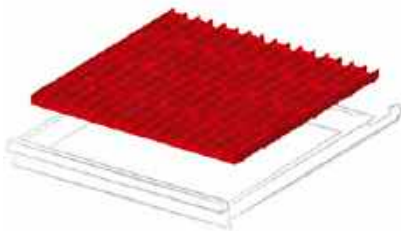

ART.	adatto per cassetto H mm	componenti	€
FFH20051700	50/300	65 x Divisorio trasversale L=36 mm 16 x Divisorio a 4 canali	36,00

ART.	adatto per cassetto H mm	componenti	€
FFH20051200	50	16 x Cassetta divisorio 75x75 mm 16 x Cassetta divisorio 150x75 mm	28,50
FFH20071200	75	4 x Cassetta divisorio 150x150 mm	37,20

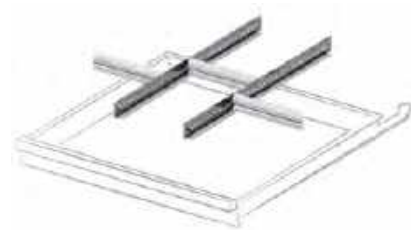
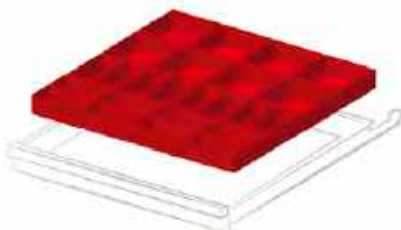

ART.	adatto per cassetto H mm	componenti	€
FFH20051300	50	16 x Cassetta divisorio 150x75 mm	24,90
FFH20071300	75	8 x Cassetta divisorio 150x150 mm	32,10
FFH20101300	100/125		40,80

ART.	adatto per cassetto H mm	componenti	€
FFH20050600	50		10,80
FFH20070600	75		14,10
FFH20100600	100/125	2 x Divisorio longitudinale fessurato L=610 mm	15,90
FFH20150600	150/175	3 x Divisorio trasversale L=202 mm	21,60
FFH20200600	200/250		33,00
FFH20300600	300		58,20



ESTRAZIONE



PORTATA



RAL 7035 + RAL 7016



RAL 5012





RAL 7035



MASTER DE 54x36 EH

CASSETTIERA L=1020 MM - CASSETTI AD ESTRAZIONE TOTALE



ART.	Lmm	Pmm	Hmm	cassetti				RAL	€
				n.	h 150 mm				
D53A100C0100104	1020	726	1000	6	6	100-75-50	92-96-100%	5012	936,30
D53A100C0100108	1020	726	1000	6	6	100-75-50	92-96-100%	7035	936,30
D53A100C01001PD	1020	726	1000	6	6	100-75-50	92-96-100%	7035+7016	1046,40



ART.	Lmm	Pmm	Hmm	cassetti									RAL	€
				n.	h 50 mm	h 75 mm	h 100 mm	h 150 mm	h 200 mm	h 300 mm				
D53A100C0100204	1020	726	1000	7	1	2	2	-	1	1	100-75-50	92-96-100%	5012	992,40
D53A100C0100208	1020	726	1000	7	1	2	2	-	1	1	100-75-50	92-96-100%	7035	992,40
D53A100C01002PD	1020	726	1000	7	1	2	2	-	1	1	100-75-50	92-96-100%	7035+7016	1124,70
D53A100C0100304	1020	726	1000	8	1	2	2	2	1	-	100-75-50	92-96-100%	5012	1077,00
D53A100C0100308	1020	726	1000	8	1	2	2	2	1	-	100-75-50	92-96-100%	7035	1077,00
D53A100C01003PD	1020	726	1000	8	1	2	2	2	1	-	100-75-50	92-96-100%	7035+7016	1230,00

MASTER DE 54x36 EH COMPONENTI

MATERIALE DI SEPARAZIONE PER CASSETTIERA L=1020 MM



TOP A 3 BORDI RIVESTITO IN PVC

ART.	Lmm	Pmm	Hmm	colore	€
M53T023AG003107	1021	729	31	Nero	83,10

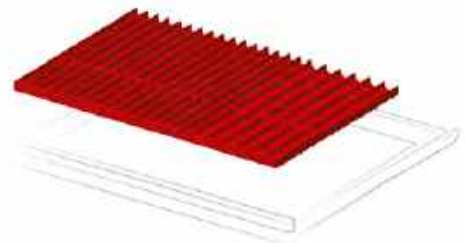
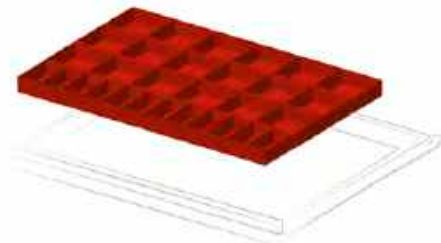

ART.	adatto per cassetto H mm	componenti	€
FFH50050800	50	12 x Cassetta divisorio 150x75 mm	35,70
FFH50070800	75	18 x Cassetta divisorio 150x150 mm	41,10
FFH50100800	100/125		49,80

ART.	adatto per cassetto H mm	componenti	€
FFH50051900	50/300	30 x Divisorio trasversale L=36 mm	42,30
		10 x Divisorio trasversale L=47 mm	
		8 x Divisorio a 3 canali 16 x Divisorio a 4 canali	

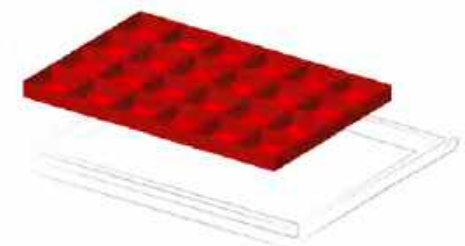
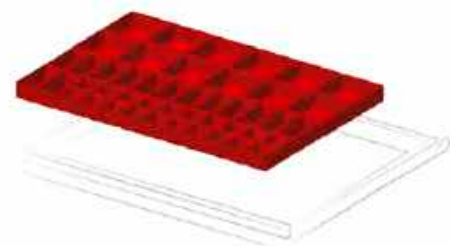

ART.	adatto per cassetto H mm	componenti	€
FFH50051700	50	20 x Cassetta divisorio 75x75 mm 14 x Cassetta divisorio 150x75 mm	40,20
FFH50071700	75	12 x Cassetta divisorio 150x150 mm	46,80

ART.	adatto per cassetto H mm	componenti	€
FFH50051800	50	24 x Cassetta divisorio 150x150 mm	33,90
FFH50071800	75		38,70
FFH50101800	100/125		45,60



ART.	adatto per cassetto H mm	componenti	€
FFH50051300	50	5 x Divisorio longitudinale fessurato L=610 mm 12 x Divisorio trasversale L=151 mm	27,90
FFH50071300	75		22,50
FFH50101300	100/125		28,20
FFH50151300	150/175		40,80
FFH50201300	200/250		70,80
FFH50301300	300		152,10

ART.	adatto per cassetto H mm	componenti	€
FFH50050700	50	4 x Divisorio longitudinale fessurato L=610 mm 2 x Divisorio trasversale L=151 mm 3 x Divisorio trasversale L=202 mm	20,10
FFH50070700	75		15,60
FFH50100700	100/125		19,20
FFH50150700	150/175		28,20
FFH50200700	200/250		50,10
FFH50300700	300		113,10



ESTRAZIONE



PORTATA



RAL 7035 + RAL 7016



RAL 5012



RAL 7035

MASTER DE 54x36 EH

ARMADIO L=1020 MM



ART.	Lmm	Pmm	Hmm	n. coppia porte	n. piano regolabile	RAL	€
D53A100C0100504	1020	726	1000	1	1	5012	541,50
D53A100C0100508	1020	726	1000	1	1	7035	541,50
D53A100C01005PD	1020	726	1000	1	1	7035+7016	541,50



ART.	Lmm	Pmm	Hmm	n. coppia porte	materiale porte	n. piano regolabile	RAL	€
D53A100C0100604	1020	726	1000	1	Policarbonato	1	5012	650,40
D53A100C0100608	1020	726	1000	1	Policarbonato	1	7035	650,40
D53A100C01006PD	1020	726	1000	1	Policarbonato	1	7035+7016	650,40

MASTER DE 54x36 EH COMPONENTI

MATERIALE DI SEPARAZIONE PER CASSETTIERA L=1020 MM



TOP A 3 BORDI RIVESTITO IN PVC

ART.	Lmm	Pmm	Hmm	colore	€
M53T023AG003107	1021	729	31	Nero	83,10



Nel Master DE l'estrazione totale è di serie.

RAL 7035 + RAL 7016

RAL 5012

RAL 7035

CASSETTIERA L=717 MM - CASSETTI AD ESTRAZIONE TOTALE



ART.	Lmm	Pmm	Hmm	cassetti							RAL	€
				n.	h 75 mm	h 100 mm	h 150 mm	h 200 mm	KG	↓		
FD109054PD	717	600	1002	7	2	1	3	1	70	100%	7035+7016	690,00
FD10905408	717	600	1002	7	2	1	3	1	70	100%	7035	630,00
FD10905404	717	600	1002	7	2	1	3	1	70	100%	5012	630,00
FD109056PD	717	600	1002	9	-	9	-	-	70	100%	7035+7016	798,00
FD10905608	717	600	1002	9	-	9	-	-	70	100%	7035	732,00
FD10905604	717	600	1002	9	-	9	-	-	70	100%	5012	732,00



ART.	Lmm	Pmm	Hmm	KG	cassetti					ruote					RAL	€	
					n.	h 100 mm	h 200 mm	KG	↓	Ø mm	Hmm	materiale	↓	↖			↙
FDG56001PD	794	600	853	225	5	4	1	70	100%	100	128	Gomma standard	1	1	2	7035+7016	621,00
FDG5600108	794	600	853	225	5	4	1	70	100%	100	128	Gomma standard	1	1	2	7035	585,00
FDG5600104	794	600	853	225	5	4	1	70	100%	100	128	Gomma standard	1	1	2	5012	585,00



RUOTAGIREVOLE



RUOTAGIREVOLE CON FRENO



RUOTA FISSA

MATERIALE DI SEPARAZIONE PER CASSETTIERA L=717 MM



TOPA 4 BORDI RIVESTITO IN PVC

ART.	Lmm	Pmm	Hmm	colore	€
FD99400107	717	602	22	Nero	63,00

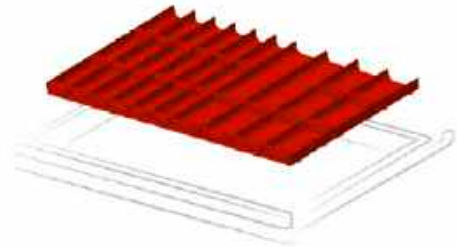
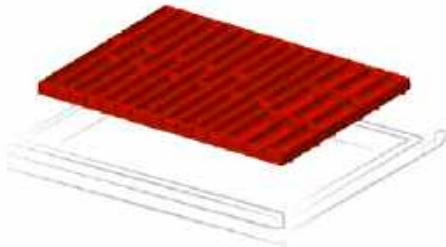

ART.	adatto per cassetto H mm	componenti	€
FFH10051000	50/300	3 x Divisorio a 3 canali 9 x Divisorio a 4 canali 12 x Divisorio trasversale L=47 mm 36 x Divisorio trasversale L=36 mm	27,60

ART.	adatto per cassetto H mm	componenti	€
FFH10051300	50/300	18 x Divisorio trasversale L=47 mm 12 x Divisorio trasversale L=73 mm 6 x Divisorio a 2 canali 6 x Divisorio a 3 canali	24,60

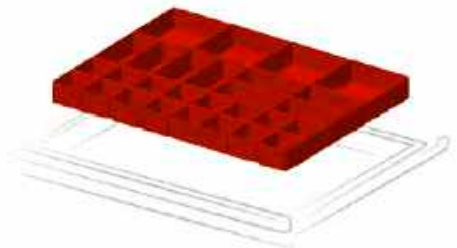
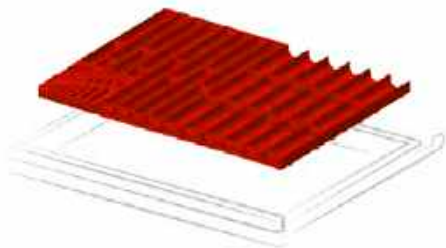

ART.	adatto per cassetto H mm	componenti	€
FFH10051500	50/300	20 x Divisorio trasversale L=36 mm 20 x Divisorio trasversale L=47 mm 6 x Divisorio a 3 canali 5 x Divisorio a 4 canali 1 x Porta chiavi a brugola	27,30

ART.	adatto per cassetto H mm	componenti	€
FFH10071800	75	16 x Cassetta divisorio 75x75 mm 8 x Cassetta divisorio 150x75 mm 4 x Cassetta divisorio 150x150 mm	27,90

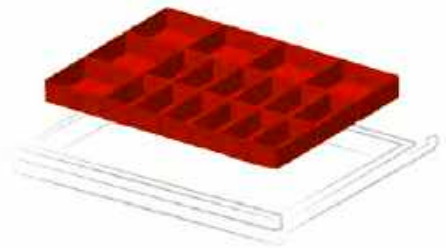

ART.	adatto per cassetto H mm	componenti	€
FFH10071600	75	12 x Cassetta divisorio 150x75 mm	24,60
FFH10101600	100/125	6 x Cassetta divisorio 150x150 mm	31,50

ART.	adatto per cassetto H mm	componenti	€
FFH10070500	75	2 x Divisorio longitudinale	14,70
FFH10100500	100/125	fessurato L=457 mm	15,30
FFH10150500	150/175	3 x Divisorio trasversale L=202 mm	20,40
FFH10200500	200/250		29,40



ESTRAZIONE



PORTATA



RAL 7035 + RAL 7016



RAL 5012



RAL 7035

MATERIALE DI SEPARAZIONE PER CASSETTIERA L=1023 MM



ART.	Lmm	Pmm	Hmm	cassetti					KG	%	RAL	€
				n.	h 75mm	h 100mm	h 150mm	h 200mm				
FDL109054PD	1023	600	1002	7	2	1	3	1	50	100%	7035+7016	846,00
FDL10905408	1023	600	1002	7	2	1	3	1	50	100%	7035	777,00
FDL10905404	1023	600	1002	7	2	1	3	1	50	100%	5012	777,00
FDL109056PD	1023	600	1002	9	-	9	-	-	50	100%	7035+7016	990,00
FDL10905608	1023	600	1002	9	-	9	-	-	50	100%	7035	900,00
FDL10905604	1023	600	1002	9	-	9	-	-	50	100%	5012	900,00



MATERIALE DI SEPARAZIONE PER CASSETTIERA L=1023 MM

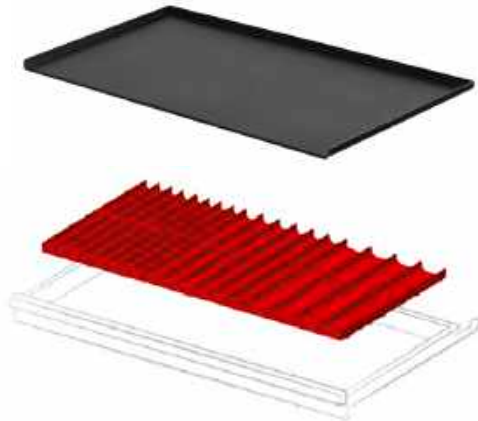

TOP A 3 BORDI RIVESTITO IN PVC

ART.	Lmm	Pmm	Hmm	colore	€
FDL91500107	1024	601	30	Nero	81,00

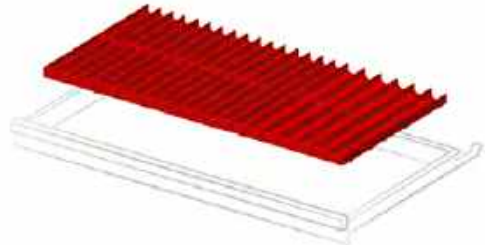

ART.	adatto per cassetto H mm	componenti	€
FFH40051200	50/300	15 x Divisorio trasversale L=36 mm 10 x Divisorio trasversale L=47 mm 6 x Divisorio trasversale L=73 mm 6 x Divisorio a 2 canali 6 x Divisorio a 3 canali 6 x Divisorio a 4 canali	34,50

ART.	adatto per cassetto H mm	componenti	€
FFH40051500	50/300	30 x Divisorio trasversale L=36 mm 10 x Divisorio trasversale L=47 mm 6 x Divisorio a 3 canali 12 x Divisorio a 4 canali	36,60

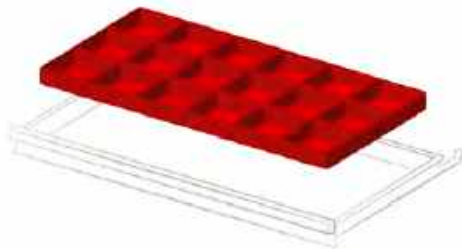

ART.	adatto per cassetto H mm	componenti	€
FFH40071100	75	18 x Cassetta divisorio 150x150 mm	33,90
FFH40101100	100/125		39,90

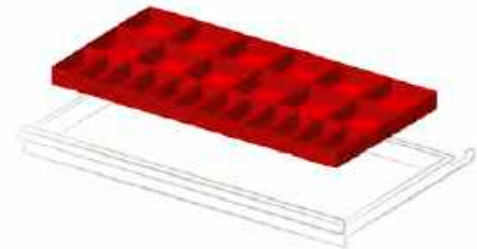

ART.	adatto per cassetto H mm	componenti	€
FFH40071300	75	12 x Cassetta divisorio 150x75 mm	36,30
FFH40101300	100/125	12 x Cassetta divisorio 150x150 mm	44,10

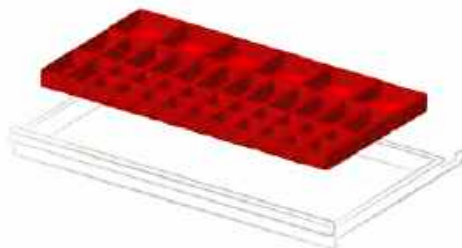

ART.	adatto per cassetto H mm	componenti	€
FFH40071600	75	20 x Cassetta divisorio 75x75 mm 14 x Cassetta divisorio 150x75 mm 6 x Cassetta divisorio 150x150 mm	42,00

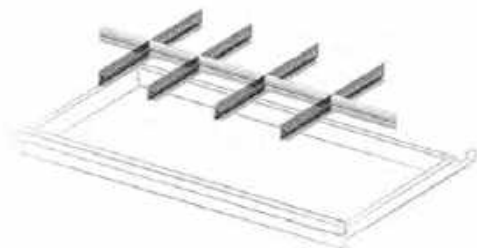

ART.	adatto per cassetto H mm	componenti	€
FFH40070500	75	4 x Divisorio longitudinale fessurato L=457 mm	21,90
FFH40100500	100/125		25,20
FFH40150500	150/175	2 x Divisorio trasversale L=151 mm	36,90
FFH40200500	200/250	3 x Divisorio trasversale L=202 mm	54,00



ESTRAZIONE



PORTATA



RAL 7035 + RAL 7016



RAL 5012



RAL 7035



ARMADIO PORTA COMPUTER CON RUOTE

ART.	Lmm	Pmm	Hmm	KG set ruote	RAL	€
MASTERC01	792	617	1731	450	7035	1283,10

Composto da:

qtà	descrizione
1	Armadio inferiore con 1 cassetto
1	Armadio superiore con porta in policarbonato
1	Maniglia a tubo
1	Piano estraibile a estrazione flessibile con maniglia Dark Grey
1	Supporto presa
1	Multipresa schuko a 4 scomparti
1	Cavo di collegamento wieland schuko/francese
1	Ventola 230V senza griglia con spina schuko
1	Kit ruote in nylon Ø 100 mm



ARMADIO SUPERIORE CON PORTA IN POLICARBONATO

ART.	Lmm	Pmm	Hmm	RAL	€
FAS1450C01008	714	247	650	7035	270,00

Possibilità di inserimento video fino a 24"



ARMADIO SUPERIORE CON TAPPARELLA

ART.	Lmm	Pmm	Hmm	RAL	€
FAS1450C02008	714	247	650	7035	300,00

Possibilità di inserimento video fino a 24"



ARMADIO INFERIORE CON 1 CASSETTO

ART.	Lmm	Pmm	Hmm	KG	n. cassette	n. piani porta tastiera	n. piani regolabili	RAL	€
FAS1400C00508	714	598	950	200	1	1	1	7035	789,00



piano porta tastiera

KITRUOTE



ART.	Ø mm	KG	H mm	materiale				€
FKRU1252101	125	300	155	Gomma antitraccia sintetica	-	2	2	46,20
FKRV1001107	100	450	128	Nylon	1	1	2	39,00



RUOTAGIREVOLE



RUOTAGIREVOLE CON FRENO



RUOTA FISSA



PIANO ESTRAIBILE A ESTRAZIONE FLESSIBILE CON MANIGLIA DARK GREY 36X27 EH

ART.	dim. utili		RAL	€
	L mm	P mm		
M32C05701101F39	602	449	7016	93,60



PIANO REGOLABILE CON SUPPORTI 36X27 EH

ART.	L mm	P mm	H mm	RAL	€
M32PR2500001139	663	560	52	7016	55,50



MANIGLIA A TUBO

ART.	L mm	P mm	H mm	RAL	€
M02R00000000007	484	80	46	9005	12,00



VENTOLA 230 V SENZA GRIGLIA CON SPINA SCHUKO

ART.	L mm	P mm	H mm	colore	€
FAS32200100	125	44	125	Nero	28,50



TOPA 3 BORDI RIVESTITO IN PVC CON FORO PASSACAVI 36X27 EH

ART.	L mm	P mm	H mm	colore	€
M32T023AG007107	715	576	31	Nero	58,20



SUPPORTO PRESA

ART.	L mm	P mm	H mm	finitura	€
FAS30210099	542	10	77	Zincato	7,50



ESEMPI SCHEMA MULTIPRESE SU SUPPORTO PRESA



Con multipresa a 4 scomparti



Con multipresa a 2 scomparti + multipresa a 4 scomparti



Con magnetotermico + multipresa a 4 scomparti

IRON TEAM

vedi pag. 86



FBLET012007



FBLET004007



FBLET005007



FBLET016007



ZINCATO



RAL 7035



RAL 7016



RAL 9005



PORTATA

STANDARD CS POSTAZIONE PC



ARMADIO PORTA COMPUTER CON RUOTE

ART.	Lmm	Pmm	Hmm	 set ruote	RAL	€
STANDARDCS01	807	654	1688	450	7035	844,50

Composto da:

qtà	descrizione
1	Armadio porta computer
1	Maniglia a tubo
1	Supporto presa
1	Piano estraibile a estrazione semplice
1	Multipresa schuko a 4 scomparti
1	Cavo di collegamento wieland schuko/francese
1	Ventola 230 V senza griglia con spina schuko
1	Kit ruote in nylon Ø 100 mm



ARMADIO PORTA COMPUTER

ART.	Lmm	Pmm	Hmm		n. piani porta tastiera	n. piani regolabili	RAL	€
FAS1600C00208	717	635	1560	400	1	2	7035	660,00
FAS1600C00204	717	635	1560	400	1	2	5012	660,00

STANDARD CS COMPONENTI

KITRUOTE



ART.	Ø mm	KG	H mm	materiale				€
FKRU1252101	125	300	155	Gomma antitraccia sintetica	-	2	2	46,20
FKRV1001107	100	450	128	Nylon	1	1	2	39,00



RUOTAGIREVOLE



RUOTAGIREVOLE CON FRENO



RUOTA FISSA



PIANO ESTRAIBILE A ESTRAZIONE SEMPLICE

ART.	Lmm	Pmm	Hmm	RAL	€
FAS2360S039	650	582	36	7016	52,80



PIANO REGOLABILE CON GANCI

ART.	Lmm	Pmm	Hmm	RAL	€
FAS2040S139	688	591	38	7016	45,60



MANIGLIA A TUBO

ART.	Lmm	Pmm	Hmm	RAL	€
FCL09950007	502	80	46	9005	13,20



VENTOLA 230 V SENZA GRIGLIA CON SPINA SCHUKO

ART.	Lmm	Pmm	Hmm	colore	€
FAS32200100	125	44	125	Nero	28,50



COPIA ZOCOLI

ART.	Lmm	Pmm	Hmm	RAL	€
FRR16250007	59	608	100	9005	42,00



SUPPORTO PRESA

ART.	Lmm	Pmm	Hmm	finitura	€
FAS30210099	542	10	77	Zincato	7,50

ESEMPI SCHEMA MULTIPRESE SU SUPPORTO PRESA



Con multipresa a 4 scomparti



Con multipresa a 2 scomparti + multipresa a 4 scomparti



Con magnetotermico + multipresa a 4 scomparti

IRON TEAM

vedi pag. 86



FBLET012007



FBLET004007



FBLET005007



FBLET016007



ZINCATO



RAL 5012



RAL 7035



RAL 7016



RAL 9005



PORTATA

PERFOM

ARMADI A PORTE BATTENTE



Guarda il video!

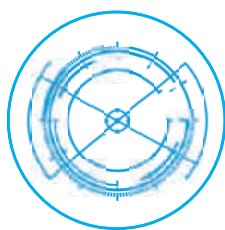

CONFIGURABILE



PORTATA 800/1200
KG

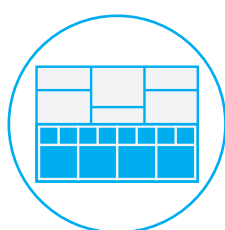

MATERIALE DI
SEPARAZIONE



CHIUSURA A CHIAVE

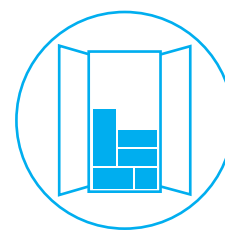

ARMADIO MONTATO +
ACCESSORI
CONFEZIONATI
ALL'INTERNO



ART.	Lmm	Pmm	Hmm	KG	RAL	€
PERFOM15001	1193	555	1000	800	7035+7016	457,50
PERFOM15002	1193	555	1000	800	7035	457,50
PERFOM15003	1193	555	1000	800	5012	457,50

Composto da:

qtà	descrizione
1	Armadio con porte a battente
1	Kit 2 piani fessurati



ART.	Lmm	Pmm	Hmm	KG	RAL	€
PERFOM15004	1193	555	1000	800	7035+7016	577,50
PERFOM15005	1193	555	1000	800	7035	577,50
PERFOM15006	1193	555	1000	800	5012	577,50

Composto da:

qtà	descrizione
1	Armadio con porte a battente
1	Cassetto a estrazione telescopica H=100 mm
1	Kit 2 piani fessurati



ART.	Lmm	Pmm	Hmm	KG	RAL	€
PERFOM15007	1193	555	1000	800	7035+7016	697,50
PERFOM15008	1193	555	1000	800	7035	697,50
PERFOM15009	1193	555	1000	800	5012	697,50

Composto da:

qtà	descrizione
1	Armadio con porte a battente
2	Cassetto a estrazione telescopica H=100 mm
1	Kit 2 piani fessurati



ART.	Lmm	Pmm	Hmm	KG	RAL	€
PERFOM15010	1193	555	1000	800	7035+7016	790,50
PERFOM15011	1193	555	1000	800	7035	790,50
PERFOM15012	1193	555	1000	800	5012	790,50

Composto da:

qtà	descrizione
1	Armadio con porte a battente
3	Cassetto a estrazione telescopica H=100 mm
1	Piano fessurato



RAL 5012



RAL 7035



RAL 7035 + RAL 7016



PORTATA



ART.	L mm	P mm	H mm	KG	RAL	€
PERFOM17001	1193	555	2000	1200	7035+7016	594,60
PERFOM17002	1193	555	2000	1200	7035	594,60
PERFOM17003	1193	555	2000	1200	5012	594,60

Composto da:

qtà	descrizione
1	Armadio con porte a battente
2	Kit 2 piani fessurati



ART.	L mm	P mm	H mm	KG	RAL	€
PERFOM17004	1193	555	2000	1200	7035+7016	954,60
PERFOM17005	1193	555	2000	1200	7035	954,60
PERFOM17006	1193	555	2000	1200	5012	954,60

Composto da:

qtà	descrizione
1	Armadio con porte a battente
3	Cassetto a estrazione telescopica H=100 mm
2	Kit 2 piani fessurati



ART.	L mm	P mm	H mm	KG	RAL	€
PERFOM17007	1193	555	2000	1200	7035+7016	1619,10
PERFOM17008	1193	555	2000	1200	7035	1619,10
PERFOM17009	1193	555	2000	1200	5012	1619,10

Composto da:

qtà	descrizione
1	Armadio con porte a battente
9	Cassetto a estrazione telescopica H=100 mm
1	Kit 2 piani fessurati



ART.	Lmm	Pmm	Hmm	KG	RAL	€
PERFOM11001	512	555	1000	800	7035+7016	256,50
FAA1120C00108	512	555	1000	800	7035	256,50
FAA1120C00104	512	555	1000	800	5012	256,50

Composto da:

qtà	descrizione
1	Armadio con porta a battente
1	Kit 2 piani fessurati



ART.	Lmm	Pmm	Hmm	KG	RAL	€
PERFOM11004	512	555	1000	800	7035+7016	313,50
PERFOM11005	512	555	1000	800	7035	313,50
PERFOM11006	512	555	1000	800	5012	313,50

Composto da:

qtà	descrizione
1	Armadio con porta a battente
1	Cassetto a estrazione semplice H=100 mm
1	Kit 2 piani fessurati



ART.	Lmm	Pmm	Hmm	KG	RAL	€
PERFOM11007	512	555	1000	800	7035+7016	418,50
PERFOM11008	512	555	1000	800	7035	418,50
PERFOM11009	512	555	1000	800	5012	418,50

Composto da:

qtà	descrizione
1	Armadio con porta a battente
3	Cassetto a estrazione semplice H=100 mm
1	Piano fessurato



ART.	Lmm	Pmm	Hmm	KG	RAL	€
PERFOM11010	512	555	1000	800	1004	321,00
PERFOM11011	512	555	1000	800	7035+7016	321,00
PERFOM11012	512	555	1000	800	7035	321,00
PERFOM11013	512	555	1000	800	5012	321,00

Composto da:

qtà	descrizione
1	Armadio con porta a battente fessurata
1	Kit 2 vasche stagne interne di raccolta liquidi capacità 9L



vedi pag. 144



RAL 1004



RAL 5012



RAL 7035



RAL 7035 + RAL 7016



PORTATA



ART.	Lmm	Pmm	Hmm	KG	RAL	€
PERFOM12001	1023	555	1000	800	7035+7016	381,00
FAA1220C00108	1023	555	1000	800	7035	381,00
FAA1220C00104	1023	555	1000	800	5012	381,00

Composto da:

qtà	descrizione
1	Armadio con porte a battente
1	Kit 2 piani fessurati



ART.	Lmm	Pmm	Hmm	KG	RAL	€
PERFOM12004	1023	555	1000	800	7035+7016	450,00
PERFOM12005	1023	555	1000	800	7035	450,00
PERFOM12006	1023	555	1000	800	5012	450,00

Composto da:

qtà	descrizione
1	Armadio con porte a battente
1	Cassetto a estrazione semplice H=100 mm
1	Kit 2 piani fessurati



ART.	Lmm	Pmm	Hmm	KG	RAL	€
PERFOM12007	1023	555	1000	800	7035+7016	565,80
PERFOM12008	1023	555	1000	800	7035	565,80
PERFOM12009	1023	555	1000	800	5012	565,80

Composto da:

qtà	descrizione
1	Armadio con porte a battente
3	Cassetto a estrazione semplice H=100 mm
1	Piano fessurato



ART.	Lmm	Pmm	Hmm	KG	RAL	€
PERFOM12010	1023	555	1000	800	7035+7016	698,10
PERFOM12011	1023	555	1000	800	7035	698,10
PERFOM12012	1023	555	1000	800	5012	691,20

Composto da:

qtà	descrizione
1	Armadio con porte a battente fessurate
1	Kit 2 piani/pannelli forati
1	Canaletta elettrica per multiprese
2	Multipresa schuko a 2 scomparti
1	Multipresa schuko a 4 scomparti
1	Magnetotermico differenziale
1	Cavo di collegamento wieland schuko/francese





ART.	Lmm	Pmm	Hmm	KG	RAL	€
PERFOM12013	1048	600	1027	800	1004	448,80
PERFOM12014	1048	600	1027	800	7035+7016	448,80
PERFOM12015	1048	600	1027	800	7035	448,80
PERFOM12016	1048	600	1027	800	5012	448,80

Composto da:

qtà	descrizione
1	Armadio con porte a battente fessurate
1	Piano fessurato
1	Vasca stagna esterna di raccolta liquidi capacità 59 L



vedi pag. 144



ART.	Lmm	Pmm	Hmm	KG	RAL	€
PERFOM12017	1023	555	1000	800	1004	435,00
PERFOM12018	1023	555	1000	800	7035+7016	435,00
PERFOM12019	1023	555	1000	800	7035	435,00
PERFOM12020	1023	555	1000	800	5012	435,00

Composto da:

qtà	descrizione
1	Armadio con porte a battente fessurate
1	Kit 2 vasche stagne interne di raccolta liquidi capacità 19 L



vedi pag. 144



ART.	Lmm	Pmm	Hmm	KG	RAL	€
PERFOM12021	1023	555	1000	800	3020	381,00
PERFOM12022	1023	555	1000	800	7035+7016	381,00
PERFOM12023	1023	555	1000	800	7035	381,00
PERFOM12024	1023	555	1000	800	5012	381,00

Composto da:

qtà	descrizione
1	Armadio con porte a battente fessurate
1	Kit 2 piani fessurati





ART.	L mm	P mm	H mm		RAL	€
PERFOM14001	1023	555	2000	1200	7035+7016	490,50
FAA1420C00108	1023	555	2000	1200	7035	471,00
FAA1420C00104	1023	555	2000	1200	5012	471,00

Composto da:

qtà	descrizione
1	Armadio con porte a battente
1	Kit 4 piani fessurati



ART.	L mm	P mm	H mm		RAL	€
PERFOM14004	1023	555	2000	1200	7035+7016	697,50
PERFOM14005	1023	555	2000	1200	7035	697,50
PERFOM14006	1023	555	2000	1200	5012	697,50

Composto da:

qtà	descrizione
1	Armadio con porte a battente
3	Cassetto a estrazione semplice H=100 mm
1	Kit 4 piani fessurati



ART.	L mm	P mm	H mm		RAL	€
PERFOM14007	1023	555	2000	1200	7035+7016	628,50
PERFOM14008	1023	555	2000	1200	7035	628,50
PERFOM14009	1023	555	2000	1200	5012	628,50

Composto da:

qtà	descrizione
1	Armadio con porte a battente fessurate in policarbonato
1	Kit 4 piani fessurati



ART.	Lmm	Pmm	Hmm	KG	RAL	€
PERFOM14055	1023	555	2000	1200	7035+7016	1627,80

Composto da:

qtà	descrizione
1	Armadio con porte a battente fessurate in policarbonato
2	Kit 2 piani/pannelli forati
3	Canaletta elettrica per multiprese
6	Multipresa schuko a 2 scomparti
3	Multipresa schuko a 4 scomparti
1	Magnetotermico differenziale
2	Cavo di collegamento wieland con spine in/out
1	Cavo di collegamento wieland schuko/francese
4	Lampada singola



RAL 5012



RAL 7035



RAL 7035 + RAL 7016



PORTATA



ART.	L mm	P mm	H mm	KG	RAL	€
PERFOM14019	1023	555	2000	1200	7035+7016	835,50
PERFOM14020	1023	555	2000	1200	7035	835,50
PERFOM14021	1023	555	2000	1200	5012	835,50

Composto da:

qtà	descrizione
1	Armadio con porte a battente fessurate
1	Vasca stagna interna di raccolta liquidi capacità 19 L
1	Kit piano fessurato con 2 separatori e 6 taniche con rubinetto a sfera
1	Kit 2 piani fessurati



ART.	L mm	P mm	H mm	KG	RAL	€
PERFOM14022	1048	600	2027	1200	7035+7016	1581,30
PERFOM14023	1048	600	2027	1200	7035	1581,30
PERFOM14024	1048	600	2027	1200	5012	1581,30

Composto da:

qtà	descrizione
1	Armadio con porte a battente fessurate
1	Vasca stagna interna di raccolta liquidi capacità 19 L
3	Kit piano fessurato con 2 separatori e 6 taniche con rubinetto a sfera
1	Piano fessurato
1	Vasca stagna esterna di raccolta liquidi capacità 59 L





ART.	Lmm	Pmm	Hmm	KG	RAL	€
PERFOM14025	1048	600	2027	1200	1004	558,60
PERFOM14026	1048	600	2027	1200	7035+7016	558,60
PERFOM14027	1048	600	2027	1200	7035	558,60
PERFOM14028	1048	600	2027	1200	5012	558,60

Composto da:

qtà	descrizione
1	Armadio con porte a battente fessurate
1	Kit 3 piani fessurati
1	Vasca stagna esterna di raccolta liquidi capacità 59L



vedi pag. 144



ART.	Lmm	Pmm	Hmm	KG	RAL	€
PERFOM14029	1023	555	2000	1200	1004	600,00
PERFOM14030	1023	555	2000	1200	7035+7016	600,00
PERFOM14031	1023	555	2000	1200	7035	600,00
PERFOM14032	1023	555	2000	1200	5012	600,00

Composto da:

qtà	descrizione
1	Armadio con porte a battente fessurate
2	Kit 2 vasche stagne interne di raccolta liquidi capacità 19 L



vedi pag. 144



ART.	Lmm	Pmm	Hmm	KG	RAL	€
PERFOM14033	1023	555	2000	1200	3020	749,40

Composto da:

qtà	descrizione
1	Armadio con porte a battente fessurate safe crash
1	Kit 3 piani fessurati
1	Piano/pannello forato
1	Parete divisorio
1	Kit tubo appendiabiti



RAL 1004



RAL 3020



RAL 5012



RAL 7035



RAL 7035 + RAL 7016



PORTATA



ART.	Lmm	Pmm	Hmm	kg	RAL	€
PERFOM14034	1023	555	2000	1200	7035+7016	1225,20
PERFOM14035	1023	555	2000	1200	7035	1225,20
PERFOM14036	1023	555	2000	1200	5012	1211,40

Composto da:

qtà	descrizione
1	Armadio con porte a battente fessurate
2	Kit 2 piani/pannelli forati
2	Canaletta elettrica per multiprese
1	Griglia per ventole
2	Ventola 230V senza griglia con spina schuko
4	Multipresa schuko a 2 scomparti
3	Multipresa schuko a 4 scomparti
1	Magnetotermico differenziale
1	Cavo di collegamento wieland con spine in/out
2	Cavo di collegamento wieland schuko/francese
1	Kit porta rotolo con carta Ø=240 mm
1	Gancio Unipok per utensili - confezione 30 pezzi
2	Mensola grande reversibile



ART.	Lmm	Pmm	Hmm	KG	RAL	€
PERFOM14037	1023	555	2000	1200	7035+7016	1239,00
PERFOM14038	1023	555	2000	1200	7035	1239,00
PERFOM14039	1023	555	2000	1200	5012	1225,20

Composto da:

qtà	descrizione
1	Armadio con porte a battente fessurate in policarbonato
2	Kit 2 piani/pannelli forati
3	Canaletta elettrica per multiprese
6	Multipresa schuko a 2 scomparti
3	Multipresa schuko a 4 scomparti
1	Magnetotermico differenziale
2	Cavo di collegamento wieland con spine in/out
1	Cavo di collegamento wieland schuko/francese



ART.	Lmm	Pmm	Hmm	KG	RAL	€
PERFOM14040	1023	555	2000	1200	7035+7016	1123,20
PERFOM14041	1023	555	2000	1200	7035	1123,20
PERFOM14042	1023	555	2000	1200	5012	1109,40

Composto da:

qtà	descrizione
1	Armadio con porte a battente fessurate
2	Kit 2 piani/pannelli forati
2	Canaletta elettrica per multiprese
2	Barra aggancio per contenitori Picking Box misura 1/2
6	Contenitore in polipropilene Picking Box misura 2
4	Multipresa schuko a 2 scomparti
2	Multipresa schuko a 4 scomparti
1	Magnetotermico differenziale
1	Cavo di collegamento wieland con spine in/out
1	Cavo di collegamento wieland schuko/francese
1	Kit porta rotolo con carta Ø=240 mm
2	Gancio Unipok per utensili - confezione 30 pezzi
2	Mensola grande reversibile



ART.	Lmm	Pmm	Hmm	KG	RAL	€
PERFOM14043	1023	555	2000	1200	7035+7016	807,30
PERFOM14044	1023	555	2000	1200	7035	807,30
PERFOM14045	1023	555	2000	1200	5012	793,50

Composto da:

qtà	descrizione
1	Armadio con porte a battente fessurate
2	Kit 2 piani/pannelli forati
2	Canaletta elettrica per multiprese
2	Multipresa schuko a 2 scomparti
2	Multipresa schuko a 4 scomparti
1	Cavo di collegamento wieland con spine in/out
1	Cavo di collegamento wieland schuko/francese



RAL 5012



RAL 7035



RAL 7035 + RAL 7016



PORTATA



ART.	Lmm	Pmm	Hmm	KG	RAL	€
PERFOM14046	1023	555	2000	1200	7035+7016	1190,40
PERFOM14047	1023	555	2000	1200	7035	1190,40
PERFOM14048	1023	555	2000	1200	5012	1176,60

Composto da:

qtà	descrizione
1	Armadio con porte a battente
3	Cassetto a estrazione semplice H=100 mm
2	Coppia pannelli forati per porta a battente
2	Kit 2 piani/pannelli forati
14	Barra aggancio per contenitori Picking Box misura 1/2
40	Contenitore in polipropilene Picking Box misura 1
12	Contenitore in polipropilene Picking Box misura 2
1	Kit porta rotolo con carta Ø=240 mm
4	Gancio Unipok per utensili - confezione 30 pezzi
2	Mensola grande reversibile



ART.	Lmm	Pmm	Hmm	KG	RAL	€
PERFOM14049	1023	555	2000	1200	7035+7016	909,60
PERFOM14050	1023	555	2000	1200	7035	909,60
PERFOM14051	1023	555	2000	1200	5012	895,80

Composto da:

qtà	descrizione
1	Armadio con porte a battente
3	Cassetto a estrazione semplice H=100 mm
2	Kit 2 piani/pannelli forati
4	Barra aggancio per contenitori Picking Box misura 1/2
12	Contenitore in polipropilene Picking Box misura 2
4	Gancio Unipok per utensili - confezione 30 pezzi



ART.	Lmm	Pmm	Hmm	KG	RAL	€
PERFOM14052	1023	555	2000	1200	7035+7016	1050,00
PERFOM14053	1023	555	2000	1200	7035	1050,00
PERFOM14054	1023	555	2000	1200	5012	1050,00

Composto da:

qtà	descrizione
1	Armadio con porte a battente
3	Cassetto a estrazione semplice H=100 mm
4	Cassetto a estrazione telescopica H=150 mm
1	Kit 2 piani fessurati



ART.	Lmm	Pmm	Hmm	KG	RAL	€
PERFOM14010	1023	555	2000	1200	7035+7016	551,40
PERFOM14011	1023	555	2000	1200	7035	551,40
PERFOM14012	1023	555	2000	1200	5012	551,40

Composto da:

qtà	descrizione
1	Armadio con porte a battente fessurate
1	Kit 3 piani fessurati
1	Piano/pannello forato
1	Parete divisorio
1	Kit tubo appendiabiti



ART.	Lmm	Pmm	Hmm	KG	RAL	€
PERFOM14013	1023	555	2000	1200	7035+7016	945,60
PERFOM14014	1023	555	2000	1200	7035	945,60
PERFOM14015	1023	555	2000	1200	5012	945,60

Composto da:

qtà	descrizione
1	Armadio con porte a battente
1	Kit 2 piani fessurati con guide
1	Kit 3 piani fessurati con guide
1	Coppia pannelli forati per porta a battente
1	Kit 3 piani fessurati
10	Barra aggancio per contenitori Picking Box misura 1/2
40	Contenitore in polipropilene Picking Box misura 1
5	Contenitore in polipropilene Picking Box misura 2
6	Contenitore in polipropilene Picking Box misura 4
20	Contenitore in polipropilene Picking Box misura 3A2
6	Contenitore in polipropilene Picking Box misura 4A2



ART.	Lmm	Pmm	Hmm	KG	RAL	€
PERFOM14016	1023	555	2000	1200	7035+7016	1082,40
PERFOM14017	1023	555	2000	1200	7035	1082,40
PERFOM14018	1023	555	2000	1200	5012	1080,00

Composto da:

qtà	descrizione
1	Armadio con porte a battente
3	Cassetto a estrazione semplice H=100 mm
2	Kit 2 piani fessurati con guide
1	Coppia pannelli forati per porta a battente
1	Piano fessurato
1	Piano/pannello forato
16	Barra aggancio per contenitori Picking Box misura 1/2
40	Contenitore in polipropilene Picking Box misura 1
23	Contenitore in polipropilene Picking Box misura 2
20	Contenitore in polipropilene Picking Box misura 3A2



RAL 5012



RAL 7035



RAL 7035 + RAL 7016



PORTATA



ARMADIO A PORTE A BATTENTE 64X27 EH

ART.	Lmm	Pmm	Hmm	KG	RAL	€
FAA1520C000PD	1193	555	1000	800	7035+7016	402,00
FAA1520C00008	1193	555	1000	800	7035	402,00
FAA1520C00004	1193	555	1000	800	5012	402,00



ARMADIO A PORTE A BATTENTE 64X27 EH

ART.	Lmm	Pmm	Hmm	KG	RAL	€
FAA1720C000PD	1193	555	2000	1200	7035+7016	483,60
FAA1720C00008	1193	555	2000	1200	7035	483,60
FAA1720C00004	1193	555	2000	1200	5012	483,60



ARMADIO A PORTE A BATTENTE 24X27 EH

ART.	Lmm	Pmm	Hmm	KG	RAL	€
FAA1120C000PD	512	555	1000	800	7035+7016	231,00
FAA1120C00008	512	555	1000	800	7035	231,00
FAA1120C00004	512	555	1000	800	5012	231,00



ARMADIO A PORTE A BATTENTE FESSURATE 24X27 EH

ART.	Lmm	Pmm	Hmm	KG	RAL	€
FAA1130C00030	512	555	1000	800	1004	231,00
FAA1130C000PD	512	555	1000	800	7035+7016	231,00
FAA1130C00008	512	555	1000	800	7035	231,00
FAA1130C00004	512	555	1000	800	5012	231,00

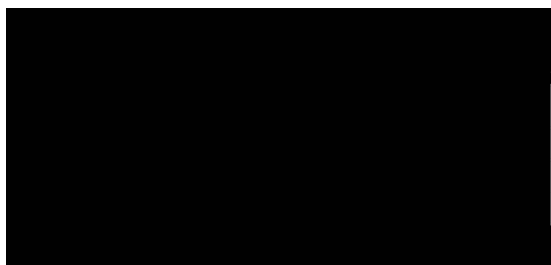

ARMADIO A PORTE A BATTENTE 54X27 EH

ART.	Lmm	Pmm	Hmm	KG	RAL	€
FAA1220C000PD	1023	555	1000	800	7035+7016	336,00
FAA1220C00008	1023	555	1000	800	7035	336,00
FAA1220C00004	1023	555	1000	800	5012	336,00



ARMADIO A PORTE A BATTENTE FESSURATE 54X27 EH

ART.	Lmm	Pmm	Hmm	KG	RAL	€
FAA1230C00030	1023	555	1000	800	1004	336,00
FAA1230C0002Y	1023	555	1000	800	3020	336,00
FAA1230C000PD	1023	555	1000	800	7035+7016	336,00
FAA1230C00008	1023	555	1000	800	7035	336,00
FAA1230C00004	1023	555	1000	800	5012	336,00



RAL 1004



RAL 3020



RAL 5012



RAL 7035



RAL 7035 + RAL 7016



PORTATA



ARMADIO A PORTE A BATTENTE 54X27 EH

ART.	Lmm	Pmm	Hmm	KG	RAL	€
FAA1420C000PD	1023	555	2000	1200	7035+7016	402,00
FAA1420C00008	1023	555	2000	1200	7035	402,00
FAA1420C00004	1023	555	2000	1200	5012	402,00



ARMADIO A PORTE A BATTENTE FESSURATE 54X27 EH

ART.	Lmm	Pmm	Hmm	KG	RAL	€
FAA1430C00030	1023	555	2000	1200	1004	402,00
FAA1430C000PD	1023	555	2000	1200	7035+7016	402,00
FAA1430C00008	1023	555	2000	1200	7035	402,00
FAA1430C00004	1023	555	2000	1200	5012	402,00





ARMADIO A PORTE A BATTENTE FESSURATE IN POLICARBONATO 54X27 EH

ART.	Lmm	Pmm	Hmm	KG	RAL	€
FAA1440C000PD	1023	555	2000	1200	7035+7016	540,00
FAA1440C00008	1023	555	2000	1200	7035	540,00
FAA1440C00004	1023	555	2000	1200	5012	540,00



ARMADIO A PORTE A BATTENTE FESSURATE SAFE CRASH 54X27 EH

ART.	Lmm	Pmm	Hmm	KG	RAL	€
FAA1440C0SC2Y	1023	555	2000	1200	3020	600,00





TOPA 3 BORDI RIVESTITI IN PVC

ART.	Lmm	Pmm	Hmm	colore	€
FAC9911290007	514	558	23	Nero	51,00
FAC9912290007	1024	558	23	Nero	67,80
FAC9915290007	1194	558	23	Nero	64,50

PIANI FESSURATI

ART.	Lmm	Pmm	Hmm	KG	finitura	€
FAC9911010099	484	500	35	120	Zincato	16,50
FAC9912010099	995	500	35	120	Zincato	22,80
FAC9915010099	1165	500	35	120	Zincato	28,50



KIT PIANI FESSURATI P=500 MM

ART.	Lmm	Pmm	Hmm	n. piani	KG	finitura	€
FAC9911020099	484	500	35	2	120	Zincato	25,50
FAC9911030099	484	500	35	3	120	Zincato	37,50
FAC9912020099	995	500	35	2	120	Zincato	45,00
FAC9912030099	995	500	35	3	120	Zincato	66,60
FAC9912040099	995	500	35	4	120	Zincato	88,50
FAC9915020099	1165	500	35	2	120	Zincato	55,50
FAC9915030099	1165	500	35	3	120	Zincato	84,00



KIT PIANI FESSURATI P=345 MM

ART.	Lmm	Pmm	Hmm	n. piani	KG	finitura	€
FAC9912050099	995	345	35	2	100	Zincato	45,00
FAC9912060099	995	345	35	3	100	Zincato	66,60



BARRE AGGANCIO CONTENITORI CON 4 CONTENITORI PICKING BOX MIS. 1

ART.	Lmm	Pmm	Hmm	colore contenitori	€
FBLIT011000	445	168	85	Grigio scuro	9,30
FBLIT029000	445	168	85	Blu	9,30

PIANO-PANNELLO FORATO

Applicabile in 3 diverse posizioni:

Pannello forato verticale



Piano orizzontale



Mensola forata a 4 bordi



PIANI-PANNELLI FORATI

ART.	Lmm	Pmm	Hmm	KG	Dim. foro mm	Passo mm	RAL	€
FAC9912070039	995	500	30	120-50	10x10	38	7016	56,40
FAC9912070008	995	500	30	120-50	10x10	38	7035	56,40
FAC9912070004	995	500	30	120-50	10x10	38	5012	54,00

KIT PIANI-PANNELLI FORATI

ART.	Lmm	Pmm	Hmm	n. piani	KG	Dim. foro mm	Passo mm	RAL	€
FAC9912080008	995	500	30	2	120-50	10x10	38	7035	108,90
FAC9912080004	995	500	30	2	120-50	10x10	38	5012	102,00
FAC9912080039	995	500	30	2	120-50	10x10	38	7016	108,90



CASSETTIAD ESTRAZIONE SEMPLICE 24X27 EH

ART.	dim. utili			KG	ESTRAZIONE	h frontale cassetto	RAL	€
	Lmm	Pmm	Hmm					
FAC9911180008	398	449	85	50	88%	100	7035	57,00
FAC9911180004	398	449	85	50	88%	100	5012	57,00
FAC9911180039	398	449	85	50	88%	100	7016	66,90



CASSETTIAD ESTRAZIONE SEMPLICE 54X27 EH

ART.	dim. utili			KG	ESTRAZIONE	h frontale cassetto	RAL	€
	Lmm	Pmm	Hmm					
FAC9912180008	908	449	85	50	88%	100	7035	69,00
FAC9912180004	908	449	85	50	88%	100	5012	69,00
FAC9912180039	908	449	85	50	88%	100	7016	83,10



CASSETTIAD ESTRAZIONE TELESCOPICA 54X27 EH

ART.	dim. utili			KG	ESTRAZIONE	h frontale cassetto	RAL	€
	Lmm	Pmm	Hmm					
FAC9912190008	908	449	85	100	100%	100	7035	93,00
FAC9912190004	908	449	85	100	100%	100	5012	93,00
FAC9912190039	908	449	85	100	100%	100	7016	106,50
FAC9912210008	908	449	135	100	100%	150	7035	99,00
FAC9912210004	908	449	135	100	100%	150	5012	99,00
FAC9912210039	908	449	135	100	100%	150	7016	117,30



CASSETTIAD ESTRAZIONE TELESCOPICA 64X27 EH

ART.	dim. utili			KG	ESTRAZIONE	h frontale cassetto	RAL	€
	Lmm	Pmm	Hmm					
FAC9915190008	1078	449	85	100	100%	100	7035	120,00
FAC9915190004	1078	449	85	100	100%	100	5012	120,00
FAC9915190039	1078	449	85	100	100%	100	7016	134,40



ZINCATO



RAL 5012



RAL 7035



RAL 7016



PORTATA



ESTRAZIONE



COPPIA PANNELLI FORATI PER PORTA A BATTENTE

ART.	L mm	P mm	H mm	Dim. foro mm	Passo mm	RAL	€
FAC9912250039	381	20	824	10x10	38	7016	49,50

Si può applicare fino ad un massimo di una coppia pannelli per porta



CANALETTA ELETTRICA PER MULTIPRESE

ART.	L mm	P mm	H mm	RAL	€
FAC9912220039	1008	64	140	7016	30,00

SCHEMA MULTIPRESE PER CANALETTA ELETTRICA



magnetotermico multipresa 4 scomparti multipresa 2 scomparti multipresa 2 scomparti USB ricarica



Applicazione canaletta elettrica sulla **parte superiore** del piano-pannello forato



Applicazione canaletta elettrica sulla **parte inferiore** del piano-pannello forato



Canaletta elettrica **integrabile** con piano-pannello forato in posizione verticale



SUPPORTO LATERALE PER MULTIPRESA

ART.	L mm	P mm	H mm	RAL	€
FAC9912240039	10	463	77	7016	14,40



Esempio di applicazione con:
 1 supporto art. FAC9912240039
 1 multipresa art. FBLET005007
 1 cavo di collegamento art. FBLET016007

SCHEMA MULTIPRESE PER SUPPORTO LATERALE



multipresa 4 scomparti



GRIGLIA PER VENTOLE

ART.	Lmm	Pmm	Hmm	RAL	€
FAC9912230039	994	123	136	7016	32,40

Esempio di applicazione con:

1 griglia art. FAC9912230039

2 ventole art. FAS32200100

1 multipresa art. FBLET005007

1 cavo di collegamento art. FBLET016007



Applicazione griglia nella **parte superiore** dell'armadio **senza** l'ausilio del **piano-pannello forato**



Applicazione griglia nella **parte superiore** dell'armadio **con** l'ausilio del **piano-pannello forato**



Applicazione griglia nella **parte inferiore** dell'armadio **con** l'ausilio del **piano-pannello forato**



VENTOLA 230 V SENZA GRIGLIA CON SPINA SCHUKO

ART.	Lmm	Pmm	Hmm	colore	€
FAS32200100	125	44	125	Nero	28,50

IRON TEAM

vedi pag. 86



FBLET012007



FBLET004007



FBLET005007



FBLET016007



FBLET014007



FBLET020007



FBL99400008

APPLICAZIONE DELLA LAMPADA SOTTO IL PIANO-PANNELLO FORATO





ZOCOLO PER TRANSPALLET COMPLETO DI CHIUSURA

ART.	Lmm	Pmm	Hmm	KG	RAL	€
FAC9912170039	1018	548	100	1200	7016	138,00
FAC9915170039	1188	550	100	1200	7016	159,00



VASCA STAGNA ESTERNA DI RACCOLTA LIQUIDI CAPACITÀ 59 L

ART.	Lmm	Pmm	Hmm	KG	L	RAL	€
FAC9912130039	1048	600	167	1200	59	7016	90,00



vedi pag. 144

VASCHE STAGNE INTERNE RACCOLTA LIQUIDI

ART.	Lmm	Pmm	Hmm	KG	L	finitura	€
FAC9911090099	484	500	42	50	9	Zincato	45,00
FAC9912090099	995	500	42	50	19	Zincato	49,50

KIT VASCHE STAGNE INTERNE RACCOLTA LIQUIDI

ART.	L mm	P mm	H mm	KG	L	n. vasche	finitura	€
FAC9911100099	484	500	42	50	9	2	Zincato	90,00
FAC9912100099	995	500	42	50	19	2	Zincato	99,00



KIT PIANO FESSURATO CON 2 SEPARATORI E 6 TANICHE CON RUBINETTO A SFERA

ART.	Lmm	Pmm	Hmm	n. taniche	L taniche	finitura piano	€
FAC9912280099	995	495	315	6	10	Zincato	339,00



1. Parete divisorio
2. Kit tubo appendiabiti
3. Piano/pannello forato
4. Kit 3 piani fessurati



PARETE DIVISORIO

ART.	Lmm	Pmm	Hmm	Passo mm	RAL	€
FAC9912260039	44	500	1616	25	7016	46,50



KITTUBO APPENDIABITI

ART.	Lmm	Pmm	Hmm	KG	finitura	€
FAC9912270099	458	23	56	15	Zincato	9,00



PIANO/PANNELLO FORATO

ART.	Lmm	Pmm	Hmm	KG	RAL	€
FAC9912070039	995	500	30	120-50	7016	56,40



KIT 3 PIANI FESSURATI

ART.	Lmm	Pmm	Hmm	n. piani	KG	finitura	€
FAC9911030099	484	500	35	3	120	Zincato	37,50



ZINCATO



RAL 7016



PORTATA



CAPACITÀ

MATERIALE DI SEPARAZIONE 24X27 EH
ARMADIO L=512 MM

MATERIALE DI SEPARAZIONE 54X27 EH
ARMADIO L=1020 MM

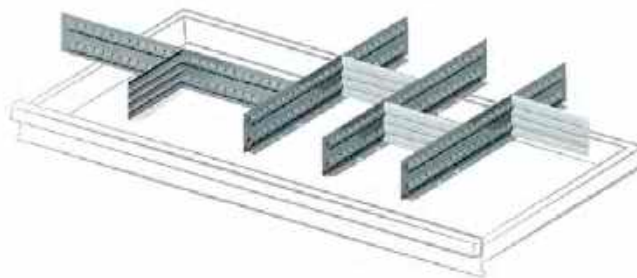

ART.	adatto per cassetto H mm	componenti	€
FFH00500100	100	2 x Divisorio trasversale L=202 mm 1 x Divisorio longitudinale fessurato L=457 mm	6,60

ART.	adatto per cassetto H mm	componenti	€
FFH02000100	100	4 x Divisorio longitudinale fessurato L=457 mm 4 x Divisorio trasversale L=151 mm	21,60

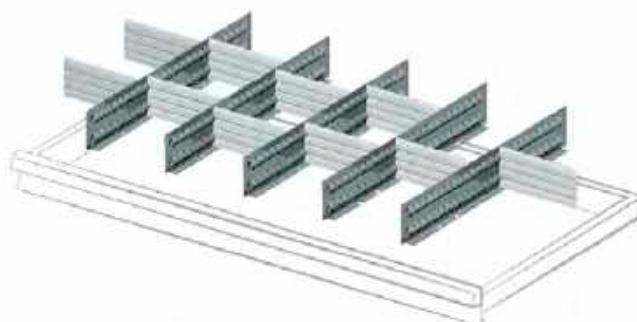
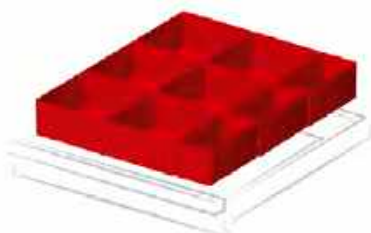

ART.	adatto per cassetto H mm	componenti	€
FFH00500800	100/125	3 x Cassetta divisorio 150x75 mm 6 x Cassetta divisorio 150x150 mm	19,50

ART.	adatto per cassetto H mm	componenti	€
FFH02000200	100	5 x Divisorio longitudinale fessurato L=457 mm 10 x Divisorio trasversale L=151 mm	33,30

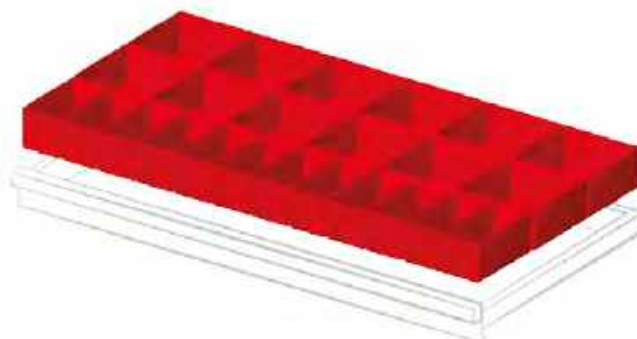
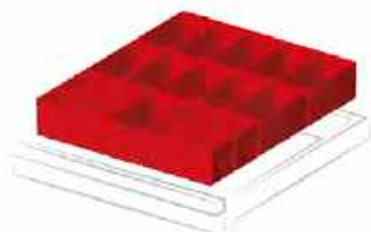

ART.	adatto per cassetto H mm	componenti	€
FFH00500900	100/125	15 x Cassetta divisorio 150x75 mm	23,70

ART.	adatto per cassetto H mm	componenti	€
FFH02000600	100/125	12 x Cassetta divisorio 150x75 mm 12 x Cassetta divisorio 150x150 mm	44,10

MATERIALE DI SEPARAZIONE
ARMADIO L=1193 MM

64X27 EH

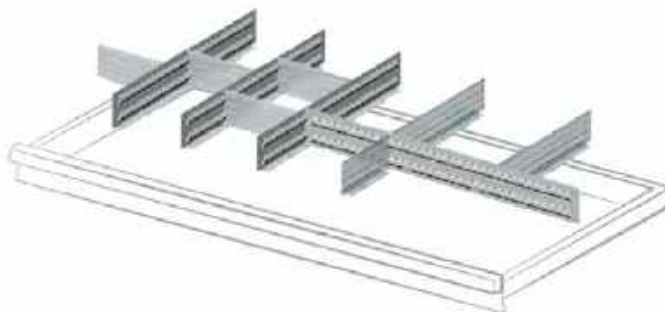

ART.	adatto per cassetto H mm	componenti	€
FFH02500300	100	3 x Divisorio longitudinale fessurato L=457 mm 1 x Divisorio longitudinale fessurato L=610 mm 3 x Divisorio trasversale L=151 mm 2 x Divisorio trasversale L=168 mm 2 x Divisorio trasversale L=304 mm	27,90

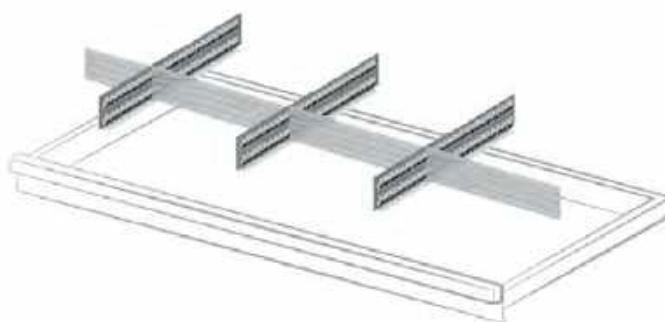

ART.	adatto per cassetto H mm	componenti	€
FFH02500400	100	3 x Divisorio longitudinale fessurato L=457 mm 1 x Divisorio trasversale L=168 mm 3 x Divisorio trasversale L=304 mm	19,80

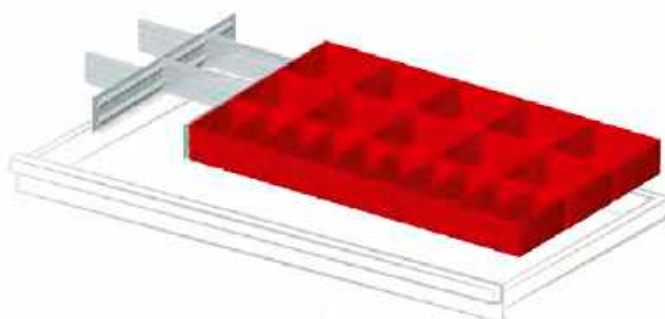

ART.	adatto per cassetto H mm	componenti	€
FFH02500600	100	10 x Cassetta divisorio 150x75 mm 10 x Cassetta divisorio 150x150 mm 2 x Divisorio longitudinale fessurato L=457 mm 2 x Divisorio trasversale L=134 mm 2 x Divisorio trasversale L=202 mm	45,30

PERFOM

ARMADI CON PORTE SCORREVOLI



PORTATA 600/800 KG



GARANZIA PORTE



CHIUSURA A CHIAVE

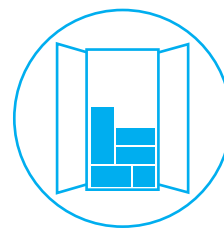

ARMADIO MONTATO



ART.	Lmm	Pmm	Hmm	KG	piani			RAL	€
					n.	Pmm	KG		
FAB5100C00208	1500	450	1000	600	1	370	100	7035	633,00
FAB5100C00204	1500	450	1000	600	1	370	100	5012	633,00



ART.	Lmm	Pmm	Hmm	KG	piani			RAL	€
					n.	Pmm	KG		
FAB5300C00208	1500	450	2000	600	4	370	100	7035	861,00
FAB5300C00204	1500	450	2000	600	4	370	100	5012	861,00



ART.	Lmm	Pmm	Hmm	KG	pervano	piani			RAL	€
						n.	Pmm	KG		
FAB7300C00108	2046	450	2000	400		8	370	100	7035	1227,00
FAB7300C00104	2046	450	2000	400		8	370	100	5012	1227,00



ART.	Lmm	Pmm	Hmm	KG	piani			RAL	€
					n.	Pmm	KG		
FAB6100C00208	1500	600	1000	600	1	500	100	7035	678,00
FAB6100C00204	1500	600	1000	600	1	500	100	5012	678,00



ART.	Lmm	Pmm	Hmm	KG	piani			RAL	€
					n.	Pmm	KG		
FAB6300C00208	1500	600	2000	600	4	500	100	7035	921,00
FAB6300C00204	1500	600	2000	600	4	500	100	5012	921,00



ART.	Lmm	Pmm	Hmm	KG pervano	piani			RAL	€
					n.	Pmm	KG		
FAB8300C00108	2046	600	2000	400	8	500	100	7035	1233,00
FAB8300C00104	2046	600	2000	400	8	500	100	5012	1233,00



ART.	Lmm	Pmm	Hmm	KG pervano	piani			cassetti			RAL	€
					n.	Pmm	KG	H 100 mm		KG		
FAB8300C00908	2046	600	2000	400	8	500	100	6	88%	50	7035	1635,00
FAB8300C00904	2046	600	2000	400	8	500	100	6	88%	50	5012	1635,00

PERFOM

ARMADI SPOGLIATOIO



PIEDINI IN POLIPROPILENE
FACILE PULIZIA

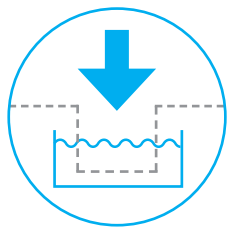

VERNICIATURA IN
ELETTROFORESI



VERSIONE CON VANO PORTA
CASCO



CHIUSURA A CHIAVE

PERFOM



ART.	Lmm	Pmm	Hmm	n. scomparti	RAL	€
PERFOMANO1	1195	502	1950	4	7035	450,00

Composto da:

qtà	descrizione
1	Armadio spogliatoio a tetto orizzontale a 4 scomparti
1	Coppia piedini per armadio spogliatoio



ART.	Lmm	Pmm	Hmm	n. scomparti	RAL	€
PERFOMANO2	1195	502	1950	3	7035	450,00

Composto da:

qtà	descrizione
1	Armadio spogliatoio a tetto orizzontale a 3 scomparti
1	Coppia piedini per armadio spogliatoio



ART.	Lmm	Pmm	Hmm	n. scomparti	RAL	€
PERFOMANO3	1195	502	2170	4	7035	517,50

Composto da:

qtà	descrizione
1	Armadio spogliatoio a tetto orizzontale a 4 scomparti
1	Tetto inclinato aggiuntivo
1	Coppia piedini per armadio spogliatoio



ART.	Lmm	Pmm	Hmm	n. scomparti	RAL	€
PERFOMANO4	1195	502	2170	3	7035	517,50

Composto da:

qtà	descrizione
1	Armadio spogliatoio a tetto orizzontale a 3 scomparti
1	Tetto inclinato aggiuntivo
1	Coppia piedini per armadio spogliatoio



RAL 7035



ART.	Lmm	Pmm	Hmm	n. scomparti	RAL	€
FAN1302C00108	608	502	1750	2	7035	264,00



ART.	Lmm	Pmm	Hmm	n. scomparti	RAL	€
FAN1303C00108	900	502	1750	3	7035	339,00

TETTO INCLINATO AGGIUNTIVO

ART.	Lmm	Pmm	Hmm	RAL	€
FAN51400008	607	502	220	7035	46,50

TETTO INCLINATO AGGIUNTIVO

ART.	Lmm	Pmm	Hmm	RAL	€
FAN51600008	899	502	220	7035	58,50



ART.	Lmm	Pmm	Hmm	n. scomparti	RAL	€
FAN1502C03108	802	502	1750	2	7035	321,00



ART.	Lmm	Pmm	Hmm	n. scomparti	RAL	€
FAN1503C03108	1192	502	1750	3	7035	438,00

TETTO INCLINATO AGGIUNTIVO

ART.	Lmm	Pmm	Hmm	RAL	€
FAN51500008	801	502	220	7035	51,00

TETTO INCLINATO AGGIUNTIVO

ART.	Lmm	Pmm	Hmm	RAL	€
FAN51800008	1191	502	220	7035	67,50

PERFOM



ART.	Lmm	Pmm	Hmm	n.scomparti	RAL	€
FAN1304C00108	1192	502	1750	4	7035	438,00

TETTO INCLINATO AGGIUNTIVO

ART.	Lmm	Pmm	Hmm	RAL	€
FAN51800008	1191	502	220	7035	67,50



COPPIA PIEDINI PER ARMADIO SPOGLIATOIO

ART.	Lmm	Pmm	Hmm	Colore	€
FRR23100001	135	500	180/200	Grigio scuro	12,00

PANCHINA SINGOLA



ART.	Lmm	Pmm	Hmm	KG	RAL	€
FAN95400001	1000	360	385/400	200	7000	72,00

ART.	Lmm	Pmm	Hmm	KG	RAL	€
FAN95500001	1494	360	385/400	200	7000	87,00

ART.	Lmm	Pmm	Hmm	KG	RAL	€
FAN95600001	2000	360	385/400	300	7000	123,00



NC

PORTA UTENSILI



CASSETTI AD ESTRAZIONE
TOTALE



ARMADIO PORTATA 1200 KG

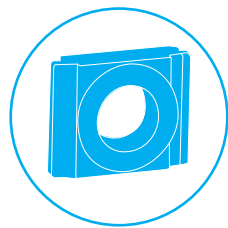

VASTA GAMMA DI BOCCOLE

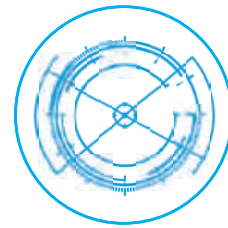

CONFIGURABILE

NC PORTA UTENSILI



ART.	Lmm	Pmm	Hmm	n. coppia telai per armadio	n. coppia telai per cassetto	n. cassetti	n. boccole	tipo boccole	RAL	€
PERFOMNC01	1023	555	2000	2	-	-	84	ISO 40	7035	912,00
PERFOMNC02	1023	555	2000	2	-	-	84	ISO 40	5012	912,00
PERFOMNC03	1023	555	2000	2	-	-	50	ISO 50	7035	825,00
PERFOMNC04	1023	555	2000	2	-	-	50	ISO 50	5012	825,00
PERFOMNC05	1023	555	2000	2	-	-	60	HSKA63-B80	7035	858,00
PERFOMNC06	1023	555	2000	2	-	-	60	HSKA63-B80	5012	858,00
PERFOMNC07	1023	555	2000	1	1	2	84	ISO 40	7035	1060,50
PERFOMNC08	1023	555	2000	1	1	2	84	ISO 40	5012	1060,50
PERFOMNC09	1023	555	2000	1	1	2	50	ISO 50	7035	973,50
PERFOMNC10	1023	555	2000	1	1	2	50	ISO 50	5012	973,50
PERFOMNC11	1023	555	2000	1	1	2	60	HSKA63-B80	7035	1006,50
PERFOMNC12	1023	555	2000	1	1	2	60	HSKA63-B80	5012	1006,50



ART.	Lmm	Pmm	Hmm	KG senza ruote	KG set ruote	n. telai	n. boccole	tipo boccole	RAL	€
COMBINC01	1064	512	892	500	825	3	35	ISO 40	7035+7000	507,00
COMBINC02	1064	512	892	500	825	3	35	ISO 40	5012+7000	507,00
COMBINC03	1064	512	892	500	825	3	25	ISO 50	7035+7000	484,50
COMBINC04	1064	512	892	500	825	3	25	ISO 50	5012+7000	484,50
COMBINC05	1064	512	892	500	825	3	25	HSKA63-B80	7035+7000	484,50
COMBINC06	1064	512	892	500	825	3	25	HSKA63-B80	5012+7000	484,50

RAL 7035

RAL 5012

RAL 5012+RAL 7000

RAL 7035+RAL 7000





PORTATA



TELAIO PORTA BOCCOLE DA BANCO

ART.	Lmm	Pmm	Hmm	RAL	€
FNC20100008	565	450	351	7035	85,20
FNC20100004	565	450	351	5012	85,20

BOCCOLA

ART.	tipo	Multiplo d'ordine	q.tà max					€
								
FNC95100003	ISO 30	7	7	21	42	35	21	3,00
FNC95300003	ISO 40	7	7	21	42	35	21	3,00
FNC95400003	ISO 45	6	6	18	30	30	18	3,30
FNC95500003	ISO 50	5	5	15	25	20	15	3,30
FNC95600003	VDI 30	7	7	21	42	35	21	3,30
FNC95700003	VDI 40	5	5	15	30	30	15	3,30
FNC95800003	VDI 50	5	5	15	30	30	15	4,20
FNC95900003	VDI 60	5	5	15	25	20	15	7,20
FNC97200003	CONO MORSE 2	7	7	21	42	35	21	3,30
FNC97300003	CONO MORSE 3	7	7	21	42	35	21	3,30
FNC97400003	CONO MORSE 4	7	7	21	42	35	21	3,30
FNC97500003	CONO MORSE 5	5	5	15	30	30	15	3,30
FNC92700003	CAPTO C3	7	7	21	42	35	21	4,20
FNC92750003	CAPTO C4	5	5	15	30	30	15	4,20
FNC92800003	CAPTO C5	5	5	15	30	30	15	4,20
FNC92850003	CAPTO C6	5	5	15	30	30	15	4,20
FNC92900003	CAPTO C8	5	5	15	20	20	15	4,20
FNC92100003	HSKA32-B40	7	7	21	42	35	21	3,30
FNC92200003	HSKA40-B50	7	7	21	42	35	21	3,30
FNC92300003	HSKA50-B63	5	5	15	30	30	15	3,30
FNC92400003	HSKA63-B80	5	5	15	30	30	15	3,30
FNC92500003	HSKA80-B100	5	5	15	20	20	15	4,20
FNC92600003	HSKA100-B125	5	5	15	20	20	15	4,20
FNC96400003	2"	6	6	18	30	30	18	4,20
FNC96500003	2" 1/4	5	5	15	25	20	15	7,20

NC COMPONENTI



ARMADIO A PORTE A BATTENTE 54X27 EH

ART.	Lmm	Pmm	Hmm	KG	RAL	€
FAA1420C000PD	1023	555	2000	1200	7035+7016	402,00
FAA1420C00008	1023	555	2000	1200	7035	402,00
FAA1420C00004	1023	555	2000	1200	5012	402,00

CASSETTI AD ESTRAZIONE TELESCOPICA 54X27 EH



ART.	dim. utili			KG	ESTRAZIONE	h frontale cassetto	RAL	€
	Lmm	Pmm	Hmm					
FAC9912190008	908	449	85	100	100%	100	7035	93,00
FAC9912190004	908	449	85	100	100%	100	5012	93,00
FAC9912190039	908	449	85	100	100%	100	7016	106,50
FAC9912210008	908	449	135	100	100%	150	7035	99,00
FAC9912210004	908	449	135	100	100%	150	5012	99,00
FAC9912210039	908	449	135	100	100%	150	7016	117,30



TELAIO PORTA BOCCOLE A 3 FILE PER CASSETTO COMPLETO DI SUPPORTI - CONFEZIONE 2 PEZZI

boccole escluse

ART.	Lmm	Pmm	Hmm	RAL	€
FNC5140S101	894	446	142/180	7000	91,50



TELAIO PORTA BOCCOLE A 3 FILE PER ARMADIO - CONFEZIONE 2 PEZZI

ART.	Lmm	Pmm	Hmm	KG	RAL	€
FNC5160S101	965	444	68	150	7000	129,00



RUOTAGIREVOLE



RUOTAGIREVOLE CON FRENO



RUOTA FISSA

CARRELLO PORTA UTENSILI CON RUOTE

ART.	Lmm	Pmm	Hmm	KG senza ruote	ruote						RAL	€
					Ø mm	materiale	KG setruote	RUOTAGIREVOLE	RUOTAGIREVOLE CON FRENO	RUOTA FISSA		
FCNF1001056	1064	512	892	500	125	Nylon	825	1	1	2	7035+7000	402,00
FCNF1001051	1064	512	892	500	125	Nylon	825	1	1	2	5012+7000	402,00



RAL 7035



RAL 5012



RAL 7016



RAL 5012 + RAL 7000



RAL 7035 + RAL 7000



RAL 7035 + RAL 7016



PORTATA



ESTRAZIONE

ECOLOGIA

Le vasche di raccolta prevengono gli sversamenti accidentali di sostanze pericolose ed inquinanti, in ottemperanza al D.Lgs. N.152/2006 e D.Lgs. N.81/2008. Attenzione! Si ricorda di non stoccare nella stessa vasca sostanze chimiche che a contatto tra loro possano reagire e di verificare la compatibilità delle sostanze pericolose stoccate con il materiale di fabbricazione di vasca e griglia. La capacità dei contenitori stoccabili sopra ogni vasca e le informazioni fornite, non esaustive né vincolanti, sono valide per il territorio italiano. Per altri Paesi, attenersi alle disposizioni specifiche vigenti nel Paese di utilizzo e contattare le autorità locali competenti per maggiori informazioni.



VASCHE DI RACCOLTA + RIPIANI E VASCHE PERFORM IN ACCIAIO
IDONEE A LIQUIDI INFIAMMABILI DELLE CATEGORIE GHS 1 – 3
E LIQUIDI INQUINANTI PER LE ACQUE DELLE CATEGORIE GHS 1 – 4. NON SONO AMMESSE SOSTANZE CORROSIVE.

VASCHE DI RACCOLTA IN PE
IDONEE A LIQUIDI INQUINANTI PER LE ACQUE DELLE CATEGORIE GHS 1 – 4.
NON SONO AMMESSE SOSTANZE INFIAMMABILI.

ECOLOGIA



BENNA RIBALTABILE CON RUOTE PREDISPOSTA PER GRIGLIA E RUBINETTO

ART.	Lmm	Pmm	Hmm	L	KG	ruote						RAL	€
						Ø mm	h mm	materiale	setruote				
FAXLT030000004	820	1370	870	285	600	125	155	Nylon	825	2	2	5012	792,00

Ruote fornite smontate



BENNA RIBALTABILE CON RUOTE PREDISPOSTA PER GRIGLIA E RUBINETTO

ART.	Lmm	Pmm	Hmm	L	KG	ruote						RAL	€
						Ø mm	h mm	materiale	setruote				
FAXLT040000004	820	1370	855	420	800	125	155	Nylon	825	2	2	5012	854,70

Ruote fornite smontate



BENNA RIBALTABILE CON RUOTE PREDISPOSTA PER GRIGLIA E RUBINETTO

ART.	Lmm	Pmm	Hmm	L	KG	ruote						RAL	€
						Ø mm	h mm	materiale	setruote				
FAXLT050000004	920	1370	900	490	1000	160	200	Nylon	1050	2	2	5012	993,30

Ruote fornite smontate



KIT RUBINETTO + GRIGLIA

ART.	Lmm	Pmm	Hmm	adatto per	RAL	€
FAXLT0300KTG004	310	730	68	FAXLT03000000 FAXLT04000000	5012	115,50
FAXLT0500KTG004	306	830	68	FAXLT05000000	5012	120,00



RUOTA GIREVOLE CON FRENO



RUOTA FISSA



RAL 5012



PORTATA



CAPACITÀ

ECOLOGIA



VASCA DI RACCOLTA PER CISTERNA

Cisterna esclusa

ART.	Lmm	Pmm	Hmm	per cisterna		RAL	€
				n.	L		
FAXVDRHV0000054	1350	1515	630	1	1000	5012+Zincato	828,60

STRUTTURA PORTA FUSTI CON VASCA DI RACCOLTA

ART.	Lmm	Pmm	Hmm	RAL	€
EC01301	1355	1255	1750	5012+Zincato	852,00

Composto da:

qtà	descrizione
1	Vasca di raccolta con griglia per 4 fusti
1	Porta fusti sovrapponibile per 2 fusti
1	Porta fusti sovrapponibile per 3 fusti



vedi pag. 144



VASCA DI RACCOLTA SENZA PARETI

ART.	Lmm	Pmm	Hmm	L	per fusti		RAL	€
					n.	L		
FML08100054	960	960	332	200	1	200	5012+Zincato	294,00
FML08200054	1355	875	332	250	2	200	5012+Zincato	333,00
FML08300054	1355	1255	290	300	4	200	5012+Zincato	414,00



vedi pag. 144



PORTA FUSTI SOVRAPPONIBILE PER 2 FUSTI

ART.	Lmm	Pmm	Hmm	per fusti		RAL	€
				n.	L		
FML08501204	1410	646	756	2	200	5012	213,00



PORTA FUSTI SOVRAPPONIBILE PER 3 FUSTI

ART.	Lmm	Pmm	Hmm	per fusti		RAL	€
				n.	L		
FML08501304	1410	646	756	3	60	5012	225,00



PORTA FUSTI NON SOVRAPPONIBILE PER 1 FUSTO

ART.	Lmm	Pmm	Hmm	per fusti		RAL	€
				n.	L		
FML08600104	876	604	386	1	200	5012	117,00

PORTA FUSTI NON SOVRAPPONIBILE PER 2 FUSTI

ART.	Lmm	Pmm	Hmm	per fusti		RAL	€
				n.	L		
FML08600204	1366	604	386	2	200	5012	138,00

ECOLOGIA



SUPPORTO IN POLIETILENE PER RIALZO

ART.	Lmm	Pmm	Hmm	perfusti		colore	€
				n.	L		
FAX002068000005	465	610	410	1	200	Giallo	129,00
FAX002070000005	1200	780	255	2	200	Giallo	315,00

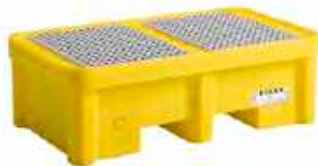

VASCA DI RACCOLTA IN POLIETILENE CON GRIGLIA PER FUSTI

ART.	Lmm	Pmm	Hmm	L	perfusti		colore	€
					n.	L		
FAX002064000005	925	800	420	225	1	200	Giallo	321,00
FAX002065000005	1350	800	420	305	2	200	Giallo	549,00
FAX002066000005	1350	1350	490	500	4	200	Giallo	750,00



vedi pag. 144



VASCA DI RACCOLTA IN POLIETILENE CON GRIGLIA PER CISTERNA

ART.	Lmm	Pmm	Hmm	L	per cisterna		colore	€
					n.	L		
FAX002067000005	1350	1350	970	1050	1	1000	Giallo	1080,00



vedi pag. 144



RAL 5012



CAPACITÀ

ECOLOGIA



ART.	Lmm	Pmm	Hmm	KG	RAL	€
PERFOM14025	1048	600	2027	1200	1004	558,60
PERFOM14026	1048	600	2027	1200	7035+7016	558,60
PERFOM14027	1048	600	2027	1200	7035	558,60
PERFOM14028	1048	600	2027	1200	5012	558,60

Composto da:

qtà	descrizione
1	Armadio con porte a battente fessurate
1	Kit 3 piani fessurati
1	Vasca stagna esterna di raccolta liquidi capacità 59 L



vedi pag. 144



ART.	Lmm	Pmm	Hmm	KG	RAL	€
PERFOM14029	1023	555	2000	1200	1004	600,00
PERFOM14030	1023	555	2000	1200	7035+7016	600,00
PERFOM14031	1023	555	2000	1200	7035	600,00
PERFOM14032	1023	555	2000	1200	5012	600,00

Composto da:

qtà	descrizione
1	Armadio con porte a battente fessurate
2	Kit 2 vasche stagne interne di raccolta liquidi capacità 19 L



vedi pag. 144



ART.	Lmm	Pmm	Hmm	KG	RAL	€
PERFOM14022	1048	600	2027	1200	7035+7016	1581,30
PERFOM14023	1048	600	2027	1200	7035	1581,30
PERFOM14024	1048	600	2027	1200	5012	1581,30

Composto da:

qtà	descrizione
1	Armadio con porte a battente fessurate
1	Vasca stagna interna di raccolta liquidi capacità 19 L
3	Kit piano fessurato con 2 separatori e 6 taniche con rubinetto a sfera
1	Piano fessurato
1	Vasca stagna esterna di raccolta liquidi capacità 59 L



ECOLOGIA



ART.	Lmm	Pmm	Hmm	KG	RAL	€
PERFOM12013	1048	600	1027	800	1004	448,80
PERFOM12014	1048	600	1027	800	7035+7016	448,80
PERFOM12015	1048	600	1027	800	7035	448,80
PERFOM12016	1048	600	1027	800	5012	448,80

Composto da:

qtà	descrizione
1	Armadio con porte a battente fessurate
1	Piano fessurato
1	Vasca stagna esterna di raccolta liquidi capacità 59 L



ART.	Lmm	Pmm	Hmm	KG	RAL	€
PERFOM12017	1023	555	1000	800	1004	435,00
PERFOM12018	1023	555	1000	800	7035+7016	435,00
PERFOM12019	1023	555	1000	800	7035	435,00
PERFOM12020	1023	555	1000	800	5012	435,00

Composto da:

qtà	descrizione
1	Armadio con porte a battente fessurate
1	Kit 2 vasche stagne interne di raccolta liquidi capacità 19 L



CLEVER-COMBI

CARRELLI



Guarda il video!



FACILI DA MONTARE



PORTATA PIANI 100 KG

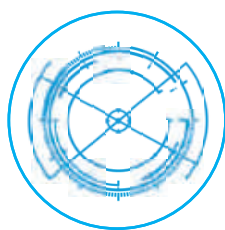

CONFIGURABILE

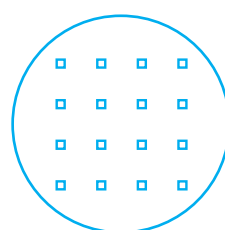

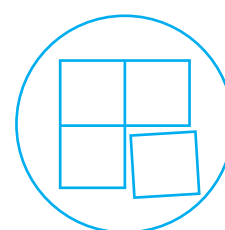

FORI QUADRI 10X10



COMPONIBILI

CLEVER SMALL





ART.	L mm	P mm	H mm	 senza ruote	 setruote	RAL	€
CLEVER0903	908	515	819	300	225	7035	141,30
CLEVER0904	908	515	819	300	225	5012	141,30

Composto da:

qtà	descrizione
1	Carrello smontato senza ruote
1	Kit ruote in gomma standard Ø 100 mm





ART.	L mm	P mm	H mm	 senza ruote	 setruote	RAL	€
CLEVER0905	908	515	819	300	225	7035	180,30
CLEVER0906	908	515	819	300	225	5012	180,30

Composto da:

qtà	descrizione
1	Carrello smontato senza ruote
1	Piano aggiuntivo
1	Kit ruote in gomma standard Ø 100 mm



ART.	L mm	P mm	H mm	 senza ruote	 setruote	RAL	€
CLEVER0907	908	515	846	300	300	7035	187,20
CLEVER0908	908	515	846	300	300	5012	187,20

Composto da:

qtà	descrizione
1	Carrello smontato senza ruote
1	Piano aggiuntivo
1	Kit ruote in gomma antitraccia sintetica Ø 125 mm



RAL 7035





RAL 5012



PORTATA

CLEVER LARGE





ART.	Lmm	Pmm	Hmm	 senza ruote	 set ruote	RAL	€
CLEVER1003	1028	615	819	300	225	7035	159,30
CLEVER1004	1028	615	819	300	225	5012	159,30

Composto da:

qtà	descrizione
1	Carrello smontato senza ruote
1	Kit ruote in gomma standard Ø 100 mm





ART.	Lmm	Pmm	Hmm	 senza ruote	 set ruote	RAL	€
CLEVER1005	1028	615	846	300	300	7035	210,00
CLEVER1006	1028	615	846	300	300	5012	210,00

Composto da:

qtà	descrizione
1	Carrello smontato senza ruote
1	Piano aggiuntivo
1	Kit ruote in gomma standard Ø 125 mm





ART.	Lmm	Pmm	Hmm	 senza ruote	 set ruote	RAL	€
CLEVER1007	1028	615	846	300	300	7035	212,70
CLEVER1008	1028	615	846	300	300	5012	212,70

Composto da:

qtà	descrizione
1	Carrello smontato senza ruote
1	Piano aggiuntivo
1	Kit ruote in gomma antistrada sintetica Ø 125 mm

CLEVER LARGE





ART.	Lmm	Pmm	Hmm	 senza ruote	 setruote	RAL	€
CLEVER1009	1028	615	868	300	300	7035	252,00
CLEVER1010	1028	615	868	300	300	5012	252,00

Composto da:

qtà	descrizione
1	Carrello smontato senza ruote
1	Piano in legno con supporti
1	Kit ruote in gomma antitraccia sintetica Ø 125 mm





ART.	Lmm	Pmm	Hmm	 senza ruote	 setruote	RAL	€
CLEVER1011	1030	615	846	300	300	7035	281,10
CLEVER1012	1030	615	846	300	300	5012	281,10

Composto da:

qtà	descrizione
1	Carrello smontato senza ruote
1	Piano aggiuntivo
2	Pannello laterale forato
1	Kit ruote in gomma antitraccia sintetica Ø 125 mm



ART.	Lmm	Pmm	Hmm	 senza ruote	 setruote	RAL	€
CLEVER1013	1030	615	868	300	300	7035	320,40
CLEVER1014	1030	615	868	300	300	5012	320,40

Composto da:

qtà	descrizione
1	Carrello smontato senza ruote
1	Piano in legno con supporti
2	Pannello laterale forato
1	Kit ruote in gomma antitraccia sintetica Ø 125 mm



RAL 7035





RAL 5012



PORTATA

CLEVER LARGE





ART.	Lmm	Pmm	Hmm	 senza ruote	 set ruote	RAL	€
CLEVER1015	1030	630	868	300	300	7035	369,90
CLEVER1016	1030	630	868	300	300	5012	369,90

Composto da:

qtà	descrizione
1	Carrello smontato senza ruote
1	Piano in legno con supporti
2	Pannello laterale forato
1	Pannello posteriore forato
1	Kit ruote in gomma antitraccia sintetica Ø 125 mm





ART.	Lmm	Pmm	Hmm	 senza ruote	 set ruote	RAL	€
CLEVER1017	1030	655	868	300	300	7035	513,90
CLEVER1018	1030	655	868	300	300	5012	513,90

Composto da:

qtà	descrizione
1	Carrello smontato senza ruote
1	Piano in legno con supporti
2	Pannello laterale forato
1	Pannello posteriore forato
1	Coppia porte a battente
1	Kit ruote in gomma antitraccia sintetica Ø 125 mm





ART.	Lmm	Pmm	Hmm	 senza ruote	 set ruote	RAL	€
CLEVER1019	1028	615	846	300	300	7035+7016	310,20
CLEVER1020	1028	615	846	300	300	5012	305,70

Composto da:

qtà	descrizione
1	Carrello smontato senza ruote
1	Piano aggiuntivo
1	Armadio L=500 mm con 1 cassetto H=150 mm
1	Kit ruote in gomma antitraccia sintetica Ø 125 mm

CLEVER LARGE





ART.	Lmm	Pmm	Hmm	 senza ruote	 setruote	RAL	€
CLEVER1021	1030	633	1538	300	300	7035	396,30
CLEVER1022	1030	633	1538	300	300	5012	396,30

Composto da:

qtà	descrizione
1	Carrello smontato senza ruote
1	Piano in legno con supporti
2	Pannello laterale forato
1	Pannello posteriore forato
1	Coppia montanti per fissaggio pannello
1	Kit ruote in gomma antitraccia sintetica Ø 125 mm



ART.	Lmm	Pmm	Hmm	 senza ruote	 setruote	RAL	€
CLEVER1023	1030	658	1538	300	300	7035	589,80
CLEVER1024	1030	658	1538	300	300	5012	589,80

Composto da:

qtà	descrizione
1	Carrello smontato senza ruote
1	Piano in legno con supporti
2	Pannello laterale forato
2	Pannello posteriore forato
1	Coppia montanti per fissaggio pannello
1	Coppia porte a battente
1	Kit ruote in gomma antitraccia sintetica Ø 125 mm



ART.	Lmm	Pmm	Hmm	 senza ruote	 setruote	RAL	€
CLEVER1025	1028	654	1538	300	300	7035+7016	425,40
CLEVER1026	1028	654	1538	300	300	5012	420,90

Composto da:

qtà	descrizione
1	Carrello smontato senza ruote
1	Piano in legno con supporti
1	Pannello posteriore forato
1	Coppia montanti per fissaggio pannello
1	Armadio L=500 mm con 1 cassetto H=150 mm
1	Kit ruote in gomma antitraccia sintetica Ø 125 mm



RAL 7035





RAL 5012



PORTATA

CLEVER LARGE



ART.	Lmm	Pmm	Hmm	 senza ruote	 set ruote	RAL	€
CLEVER1027	1347	633	1538	300	300	7035	617,10
CLEVER1028	1347	633	1538	300	300	5012	617,10

Composto da:

qtà	descrizione
1	Carrello smontato senza ruote
1	Piano in legno con supporti
2	Pannello laterale forato
1	Pannello posteriore forato
1	Coppia montanti per fissaggio pannello
1	Mensola grande reversibile
1	Barra aggancio con 3 contenitori Picking Box misura 2
1	Porta bombolette a 6 posti
2	Porta silicone inclinato a 2 posti
1	Kit porta rotolo con carta Ø=240 mm
2	Calamita completa di clip e vite - confezione 10 pezzi
1	Kit ruote in gomma antitraccia sintetica Ø 125 mm

CLEVER SMALL LARGE COMPONENTI



CARRELLO SMONTATO SENZA RUOTE

ART.	Lmm	Pmm	Hmm	KG	RAL	€
FCR10S0X208	908	515	691	300	7035	102,00
FCR10S0X204	908	515	691	300	5012	102,00
FCR11S0X208	1028	615	691	300	7035	120,00
FCR11S0X204	1028	615	691	300	5012	120,00



KIT RUOTE

ART.	Ø	KG	Hmm	materiale			€
FKRD1002107	100	225	128	Gomma standard	2	2	39,30
FKRB1252107	125	300	155	Gomma standard	2	2	43,50
FKRU1252101	125	300	155	Gomma antitraccia sintetica	2	2	46,20
FKRS1252101	125	750	155	Gomma elastica	2	2	75,90



PIANO AGGIUNTIVO

ART.	Lmm	Pmm	Hmm	adatto per	KG	RAL	€
FCR10120108	810	510	35	Carrello Clever Small	100	7035	39,00
FCR10120104	810	510	35	Carrello Clever Small	100	5012	39,00
FCR11120108	930	610	35	Carrello Clever Large	100	7035	46,50
FCR11120104	930	610	35	Carrello Clever Large	100	5012	46,50



RUOTA GIREVOLE CON FRENO



RUOTA FISSA



PORTATA



RAL 7035



RAL 5012

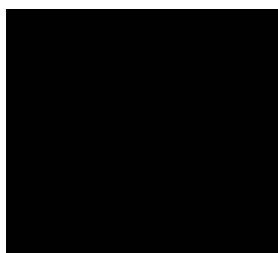

PANNELLO POSTERIORE FORATO

ART.	L mm	P mm	H mm	adatto per	Dim. foro mm	Passo mm	RAL	€
FCR11150108	895	22	690	Carrello Clever	10x10	38	7035	49,50
FCR11150104	895	22	690	Carrello Clever Large	10x10	38	5012	49,50



Per l'installazione sulla parte superiore del carrello è necessario ordinare la coppia montanti



COPIA MONTANTI PER FISSAGGIO PANNELLO

ART.	Lmm	Pmm	Hmm	RAL	€
FCR10170139	45	35	650	7016	26,40



Per l'installazione sulla parte superiore del carrello è necessario ordinare la coppia montanti



COPIA PORTEA BATTENTE

ART.	L mm	P mm	H mm	adatto per	Dim. foro mm	Passo mm	RAL	€
FCR11160108	936	44	690	Carrello Clever	10x10	38	7035	144,00
FCR11160104	936	44	690	Carrello Clever Large	10x10	38	5012	144,00



PANNELLO LATERALE FORATO

ART.	L mm	P mm	H mm	adatto per	Dim. foro mm	Passo mm	RAL	€
FCR11140108	573	7	688	Carrello Clever	10x10	38	7035	34,20
FCR11140104	573	7	688	Carrello Clever Large	10x10	38	5012	34,20

CLEVER

LARGE

COMPONENTI



PIANO IN LEGNO CON SUPPORTI

ART.	Lmm	Pmm	Hmm	adatto per	KG	€
FCR11130100	930	610	51	Carrello Clever Large	100	85,80



ARMADIO L=500 MM CON 1 CASSETTO H=150 MM

ART.	Lmm	Pmm	Hmm	KG	RAL	€
FBG03S50C0001PD	500	630	210	25	7035+7016	97,50
FBG03S50C000104	500	630	210	25	5012	93,00

GANCI



CMV10001



CMV10016



CMV10022



CMV10036

IRONTEAM

vedi pag. 80



FBL95410000



FBLIT008039



FBLIT004039



FBLIT010039



FBLIT013000



FBLIT017039



FBLET012007



FBLET004007



FBLET005007



FBLET016007



RAL 7016



RAL 7035+RAL 7016



RAL 7035



RAL 5012



PORTATA

CLEVER LARGE



ART.	L mm	P mm	H mm	KG	KG	RAL	€
				senza ruote	set ruote		
CLEVER1029	1347	658	1538	300	300	7035	972,60
CLEVER1030	1347	658	1538	300	300	5012	972,60





Composto da:

qtà	descrizione
1	Carrello smontato senza ruote
1	Piano in legno con supporti
2	Pannello laterale forato
2	Pannello posteriore forato
1	Coppia montanti per fissaggio pannello
1	Coppia porte a battente
1	Kit porta rotolo con carta Ø=240 mm
1	Porta bombolette a 6 posti
2	Mensola grande reversibile
1	Cestino capacità 30 L
1	Cavo di collegamento wieland schuko/francese
1	Multipresa schuko a 4 scomparti
1	Multipresa schuko a 2 scomparti
1	Supporto multipresa a 4 scomparti
1	Supporto multipresa a 2 scomparti
2	Calamita completa di clip e vite - confezione 10 pezzi
1	Kit ruote in gomma antitraccia sintetica Ø 125 mm

COMBI







CARRELLO CON BASE IN ACCIAIO CON RUOTE

ART.	Lmm	Pmm	Hmm	 senza ruote	ruote						RAL	€
					∅ mm	materiale	 set ruote					
FCEP1052004	1095	700	1000	500	200	Gomma standard	615	1	1	2	5012	294,00





CARRELLO CON BASE IN ACCIAIO CON RUOTE

ART.	Lmm	Pmm	Hmm	 senza ruote	ruote						RAL	€
					∅ mm	materiale	 set ruote					
FCEB1050308	1135	700	915	500	125	Gomma standard	300	1	1	2	7035	151,20
FCEB1050304	1135	700	915	500	125	Gomma standard	300	1	1	2	5012	151,20



CARRELLO CON BASE IN ACCIAIO CON RUOTE

ART.	Lmm	Pmm	Hmm		ruote		RAL	€
					∅ mm			
FCR00210008	555	445	845	150	100	4	7035	114,00
FCR00210004	555	445	845	150	100	4	5012	114,00



RUOTA GIREVOLE CON FRENO



RUOTA GIREVOLE



RUOTA FISSA



RAL 7035



RAL 5012



PORTATA

BIN CART

CARRELLI COMPONENTI MULTIUSO



FACILI DA MONTARE



PORTATA CARRELLO 300 KG

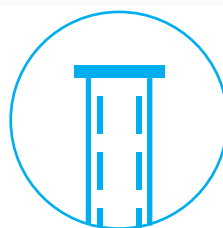

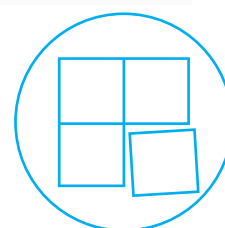

MONTANTE FORATO PASSO
38 MM



COMPONIBILI

BIN CART





ART.	L mm	P mm	H mm	 senza ruote	 set ruote	RAL	€
BINCART0701	761	668	1357	300	300	7016	616,80

Composto da:

qtà	descrizione
1	Carrello smontato senza ruote
2	Coppia supporti totali per Visual Box
2	Profilo in alluminio per Picking Box
2	Cassettiera Visual Box con 3 cassetti H=240 mm
2	Cassettiera Visual Box con 4 cassetti H=206 mm
4	Cassettiera Visual Box con 5 cassetti H=164 mm

qtà	descrizione
6	Cassettiera Visual Box con 6 cassetti H=112 mm
2	Fermo per cassetteria Visual Box con 3 cassetti
2	Fermo per cassetteria Visual Box con 4 cassetti
4	Fermo per cassetteria Visual Box con 5 cassetti
6	Fermo per cassetteria Visual Box con 6 cassetti
1	Kit ruote in gomma antitraccia sintetica Ø 125 mm



ART.	L mm	P mm	H mm	 senza ruote	 set ruote	RAL	€
BINCART1005	1067	668	1677	300	300	7016	423,60

Composto da:

qtà	descrizione
1	Carrello smontato senza ruote
3	Pannello non forato/mensola
1	Pannello forato/mensola con 1 bordo fermacasse
1	Coppia squadrette a L
1	Snodo per piastra



qtà	descrizione
1	Piastra porta monitor con standard VESA
1	Supporto multipresa a 4 scomparti
1	Multipresa schuko a 4 scomparti
1	Cavo di collegamento wieland schuko/francese
1	Kit ruote in gomma antitraccia sintetica Ø 125 mm

RAL 7016

PORTATA

BIN CART





ART.	L mm	P mm	H mm	 senza ruote	 set ruote	RAL	€
BINCART1001	1067	668	1357	300	300	7016	530,40

Composto da:

qtà	descrizione
1	Carrello smontato senza ruote
2	Set 5 profili con 90 contenitori Picking Box misura 1
1	Kit ruote in gomma antitraccia sintetica Ø 125 mm





ART.	L mm	P mm	H mm	 senza ruote	 set ruote	RAL	€
BINCART1002	1067	668	1357	300	300	7016	501,30

Composto da:

qtà	descrizione
1	Carrello smontato senza ruote
1	Set 5 profili con 90 contenitori Picking Box misura 1
1	Set 4 profili con 48 contenitori Picking Box misura 2
1	Kit ruote in gomma antitraccia sintetica Ø 125 mm

BIN CART





ART.	L mm	P mm	H mm	 senza ruote	 set ruote	RAL	€
BINCART1003	1067	668	1357	300	300	7016	472,20

Composto da:

qtà	descrizione
1	Carrello smontato senza ruote
2	Set 4 profili con 48 contenitori Picking Box misura 2
1	Kit ruote in gomma antitraccia sintetica Ø 125 mm





ART.	L mm	P mm	H mm	 senza ruote	 set ruote	RAL	€
BINCART1004	1067	668	1357	300	300	7016	344,10

Composto da:

qtà	descrizione
1	Carrello smontato senza ruote
3	Pannello forato/mensola con 1 bordo fermacasse
1	Profilo in alluminio per Picking Box
1	Kit ruote in gomma antitraccia sintetica Ø 125 mm



CARRELLO SMONTATO SENZA RUOTE

ART.	Lmm	Pmm	Hmm		 per lato	RAL	€
FBC10070039	709	668	1201	300	150	7016	106,80



PROFILO IN ALLUMINIO PER PICKING BOX

ART.	Lmm	Pmm	Hmm	per carrello Lmm		per contenitori mis.	materiale	€
FBC25070000	705	35	60	709	40	1/2	Alluminio	13,80



COPIA SUPPORTI PARZIALI PER VISUAL BOX

ART.	Lmm	Pmm	Hmm	per carrello Lmm		RAL	€
FBC30070139	649	50	319	709	75	7016	21,60



COPIA SUPPORTI TOTALI PER VISUAL BOX

ART.	Lmm	Pmm	Hmm	per carrello Lmm		RAL	€
FBC30070239	649	50	1153	709	150	7016	33,60

BIN CART 700 COMPONENTI

VISUAL BOX

vedi Visual Box pag. 190



FAXVBCH00900001 FAXVBCH00600001 FAXVBCH00500001 FAXVBCH00400001 FAXVBCH00300001 FAXVBCH00200001



PANNELLO NON FORATO/MENSOLA

Può essere utilizzato come chiusura della base del carrello

ART.	L mm	P mm	H mm	 KG	RAL	€
FBL76580008	647	494	30	50	7035	30,00





PANNELLO FORATO/MENSOLA CON 1 BORDO FERMACASSE

ART.	L mm	P mm	H mm	Dim. foro mm	Passo mm	RAL	€
FBL76080108	647	60	456	10x10	38	7035	38,40
FBL76080104	647	60	456	10x10	38	5012	38,40



KIT RUOTE

ART.	Ø	 KG	H mm	materiale			€
FKRD1002107	100	225	128	Gomma standard	2	2	39,30
FKRB1252107	125	300	155	Gomma standard	2	2	43,50
FKRU1252101	125	300	155	Gomma antitraccia sintetica	2	2	46,20
FKRS1252101	125	750	155	Gomma elastica	2	2	75,90



RUOTA GIREVOLE CON FRENO



RUOTA FISSA



RAL 7016



RAL 7035



RAL 5012



PORTATA

BIN CART 1000 COMPONENTI



CARRELLO SMONTATO SENZA RUOTE

ART.	Lmm	Pmm	Hmm	KG	KG per lato	RAL	€
FBC10100039	1015	668	1201	300	150	7016	114,00



PROFILO IN ALLUMINIO PER PICKING BOX

ART.	Lmm	Pmm	Hmm	per carrello L mm	KG	per contenitori mis.	materiale	€
FBC25100000	1011	35	60	1015	40	1/2	Alluminio	17,40



PANNELLO NON FORATO/MENSOLA

Può essere utilizzato come chiusura della base del carrello

ART.	Lmm	Pmm	Hmm	KG	RAL	€
FBL76680008	953	494	30	50	7035	37,80



PANNELLO FORATO/MENSOLA CON 1 BORDO FERMACASSE

ART.	Lmm	Pmm	Hmm	Dim. foro mm	Passo mm	RAL	€
FBL76170108	953	60	456	10x10	38	7035	55,50
FBL76170104	953	60	456	10x10	38	5012	55,50

BIN CART 1000 COMPONENTI



SET 4 PROFILI CON 48 CONTENITORI PICKING BOX MISURA 2

ART.	per carrello Lmm	contenitori mis.	colore	€
FBC25100201	1015	2	Grigio scuro	156,00





SET 5 PROFILI CON 90 CONTENITORI PICKING BOX MISURA 1

ART.	per carrello Lmm	contenitori mis.	colore	€
FBC25100101	1015	1	Grigio scuro	185,10



KIT RUOTE

ART.	Ø	KG	H mm	materiale			€
FKRD1002107	100	225	128	Gomma standard	2	2	39,30
FKRB1252107	125	300	155	Gomma standard	2	2	43,50
FKRU1252101	125	300	155	Gomma antitraccia sintetica	2	2	46,20
FKRS1252101	125	750	155	Gomma elastica	2	2	75,90



RUOTA GIREVOLE CON FRENO



RUOTA FISSA



RAL 7016



RAL 7035



RAL 5012



PORTATA

ST SCAFFALI



FACILI DA MONTARE

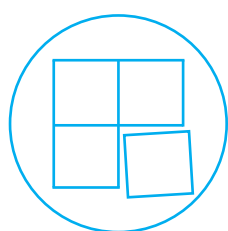

COMPONIBILI

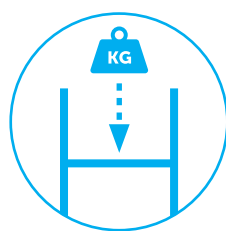

PORTATA PIANI FINO A 300 KG



PORTATA CAMPATA 2300 KG

ST



ART.	Lmm	Pmm	Hmm	finitura	€
ST2001	2115	523	2003	Zincato	363,00

Composto da:

qtà	descrizione
3	Fiancata con 3 traversini
2	Kit 5 piani fessurati



KIT 5 RINFORZI PER PIANI FESSURATI

ART.	Lmm	Pmm	Hmm	finitura	€
FUF20000199	993	50	33	Zincato	24,00

Aumenta la portata del piano fessurato a 300 kg



KIT 5 PIANI FESSURATI

ART.	Lmm	Pmm	Hmm	KG	finitura	€
FST10402099	1000	400	35	120	Zincato	105,00
FST10502099	1000	500	35	120	Zincato	114,00



ART.	Lmm	Pmm	Hmm	finitura	€
ST2601	2715	423	2003	Zincato	280,50

Composto da:

qtà	descrizione
3	Fiancata con 3 traversini
2	Kit 3 coppie supporti porta pneumatici



KIT 3 COPPIE SUPPORTI PORTA PNEUMATICI

ART.	Lmm	Pmm	Hmm	KG	finitura	€
FST95900199	1300	32	100	50	Zincato	75,00

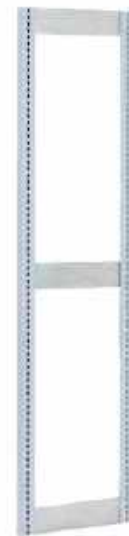

FIANCATA CON TRAVERSINI

ART.	Pmm	Hmm	finitura	€
FST02034099	423	2003	Zincato	43,50
FST02035099	523	2003	Zincato	45,00



STORAGE DOMINO

SCAFFALI

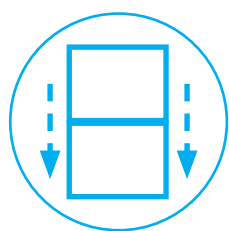

SOVRAPPONIBILI

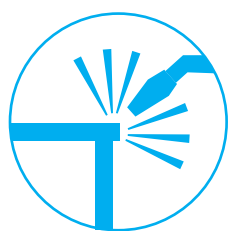

STRUTTURA SALDATA



PORTATA MODULO FINO A
1600 KG



FERMO ANTICADUTA

STORAGE DOMINO



ART.	Lmm	Pmm	Hmm	RAL	€
FED30440101	1025	355	885	7000	312,90

Composto da:

qtà	descrizione
1	Scaffale a 16 posti per contenitori misura 3
16	Contenitore in polipropilene Picking Box misura 3

SOVRAPPONIBILITÀ



n. telai sovrapposti	 di ogni telaio	 di ogni box
2	960	60
3	640	40



ART.	Lmm	Pmm	Hmm	RAL	€
FED40540101	1765	500	885	7000	499,80

Composto da:

qtà	descrizione
1	Scaffale a 20 posti per contenitori misura 4
20	Contenitore in polipropilene Picking Box misura 4

SOVRAPPONIBILITÀ

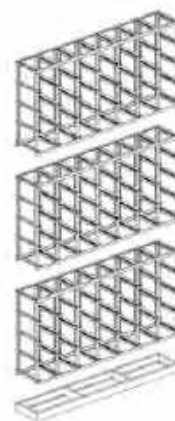

n. telai sovrapposti	 di ogni telaio	 di ogni box
3	1600	80

RAL 7000

PORTATA

STORAGE DOMINO



ART.	L mm	P mm	H mm	RAL	€
FED30440201	1025	355	885	7000	487,80

Composto da:

qtà	descrizione
1	Scaffale a 16 posti per contenitori misura 3
16	Contenitore in metallo misura 3

SOVRAPPONIBILITÀ



n. telai sovrapposti	 di ogni telaio	 di ogni box
2	960	60
3	640	40



ART.	L mm	P mm	H mm	RAL	€
FED40540201	1765	500	885	7000	755,40

Composto da:

qtà	descrizione
1	Scaffale a 20 posti per contenitori misura 4
20	Contenitore in metallo misura 4

SOVRAPPONIBILITÀ

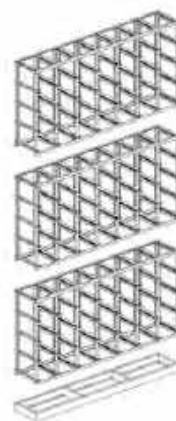

n. telai sovrapposti	 di ogni telaio	 di ogni box
3	1600	80

STORAGE DOMINO

COMPONENTI



SCAFFALEVUOTO

ART.	Lmm	Pmm	Hmm	RAL	€
FED30440A01	1025	310	885	7000	249,90



SCAFFALEVUOTO

ART.	Lmm	Pmm	Hmm	RAL	€
FED40540A01	1765	460	885	7000	312,00



COPERCHIO PARAPOLVERE

ART.	Lmm	Pmm	Hmm	RAL	€
FED90340001	1020	315	20	7000	25,20



COPERCHIO PARAPOLVERE

ART.	Lmm	Pmm	Hmm	RAL	€
FED90450001	1765	465	20	7000	36,00



ZOCCOLO DI APPOGGIO

ART.	Lmm	Pmm	Hmm	RAL	€
FED92340001	1020	313	85	7000	48,00



ZOCCOLO DI APPOGGIO

ART.	Lmm	Pmm	Hmm	RAL	€
FED92450001	1765	463	85	7000	70,20



STEEL

CASSETTE, CONTENITORI E CONTAINERS IN METALLO

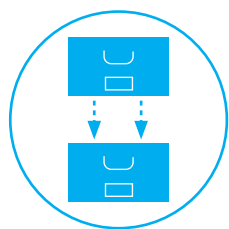

IMPILABILI

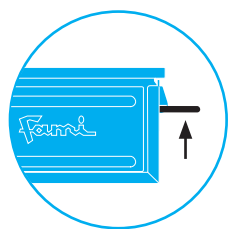

MANIGLIA BLOCCO A 90°

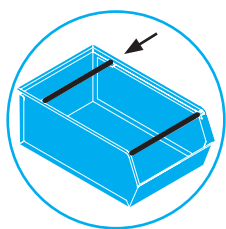

TRAVERSINO DI
SOLLEVAMENTO



ROBUSTI

STEEL



272-3A2



272-3



272-4



272-4A5



272-5

ART.	multiplo d'ordine	mis.	dim. ingombro			dim. utili			L	RAL	€
			Lmm	Pmm	Hmm	Lmm	Pmm	Hmm			
FLA33200A01	10	272-3A2	325	210	145	300	200	130	8,7	7000	20,10
FLA41200A01	8	272-3	325	210	200	300	200	185	12	7000	21,60
FLA65200A01	6	272-4	480	315	200	450	300	185	27	7000	25,20
FLA73200A01	4	272-4A5	480	315	300	450	300	280	40,5	7000	40,50
FLA89200A01	6	272-5	680	450	300	630	450	280	85	7000	61,50



RAL7000

CAPACITÀ

STEEL



1

2

3A2

3

ART.	multiplo d'ordine	mis.	dim. ingombro			dim. utili			L	RAL	€
			Lmm	Pmm	Hmm	Lmm	Pmm	Hmm			
FLS17000A01	20	1	105	165	75	95	140	65	1	7000	4,20
FLS25000A01	20	2	150	235	125	140	195	115	3,8	7000	8,40
FLS33000A01	10	3A2	210	350	145	195	300	135	9,4	7000	15,90
FLS41000A01	8	3	210	350	200	200	300	185	12,5	7000	17,10



3P4

4A2

4

4A5

ART.	multiplo d'ordine	mis.	dim. ingombro			dim. utili			L	RAL	€
			Lmm	Pmm	Hmm	Lmm	Pmm	Hmm			
FLS49000A01	9	3P4	210	550	200	200	450	185	18	7000	24,30
FLS57000A01	8	4A2	310	500	145	300	450	135	20	7000	27,30
FLS65000A01	6	4	310	510	200	300	450	185	28	7000	23,40
FLS73000A01	4	4A5	310	525	315	300	450	280	42	7000	37,20

TRAVERSINO DI SOLLEVAMENTO ABBINATO ALLA MANIGLIA BLOCCO A 90°



STEEL



5P4



5



5P4



5

ART.	multiplo d'ordine	mis.	dim. ingombro			dim. utili			n. slitte	L	RAL	€
			Lmm	Pmm	Hmm	Lmm	Pmm	Hmm				
FLS81000A01	6	5P4	480	540	300	450	450	280	-	63	7000	50,10
FLS89000A01	6	5	480	725	295	450	630	280	-	88	7000	52,50
FLS81100A01	4	5P4	480	540	385	450	450	280	2	63	7000	74,70
FLS89100A01	4	5	480	725	385	450	630	280	2	88	7000	75,90



4



4A5



5P4



5

ART.	multiplo d'ordine	mis.	dim. ingombro			dim. utili			L	RAL	€
			Lmm	Pmm	Hmm	Lmm	Pmm	Hmm			
FLS65010A01	6	4	310	510	200	300	450	185	28	7000	30,90
FLS73010A01	4	4A5	310	525	315	300	450	280	42	7000	46,20
FLS81010A01	6	5P4	480	540	300	450	450	280	63	7000	61,50
FLS89010A01	6	5	480	725	295	450	630	280	88	7000	63,90

APPLICAZIONI SPECIALI

CONTENITORI CON DOPPIO TRAVERSINO



sistema di prelevamento
con carrello elevatore

CONTENITORI CON SLITTA



sistema di prelevamento
con carrello elevatore



RAL 7000



CAPACITÀ

STEEL



CONTAINER CON FONDO APRIBILE A RULLI

ART.	Lmm	Pmm	Hmm	KG	RAL	€
FML01210001	1095	865	1265	2000	7000	740,40

CONTAINER CON FONDO APRIBILE A RULLI

ART.	Lmm	Pmm	Hmm	KG	RAL	€
FML01110001	1095	865	915	2000	7000	641,10

CONTAINERS CON FONDO APRIBILE A RULLI

Sollevati con carrello elevatore tramite le quattro maniglie saldate al bordo superiore, consentono di scaricare il materiale per mezzo del fondo apribile a rulli (apertura dell'87%). L'apertura avviene in modo facile e sicuro tramite la leva posta sul lato da 800 mm, mentre la chiusura mediante un particolare dispositivo composto di leve e rulli d'acciaio.



STEEL



CONTAINER BOCCA DI LUPO

ART.	multiplo d'ordine	Lmm	Pmm	Hmm		RAL	€
FML05100A01	3	830	680	600	1000	7000	162,00





RAL 7000

PORTATA

EURO BOX-NESTABLE BOX- PICKING BOX-VISUAL BOX

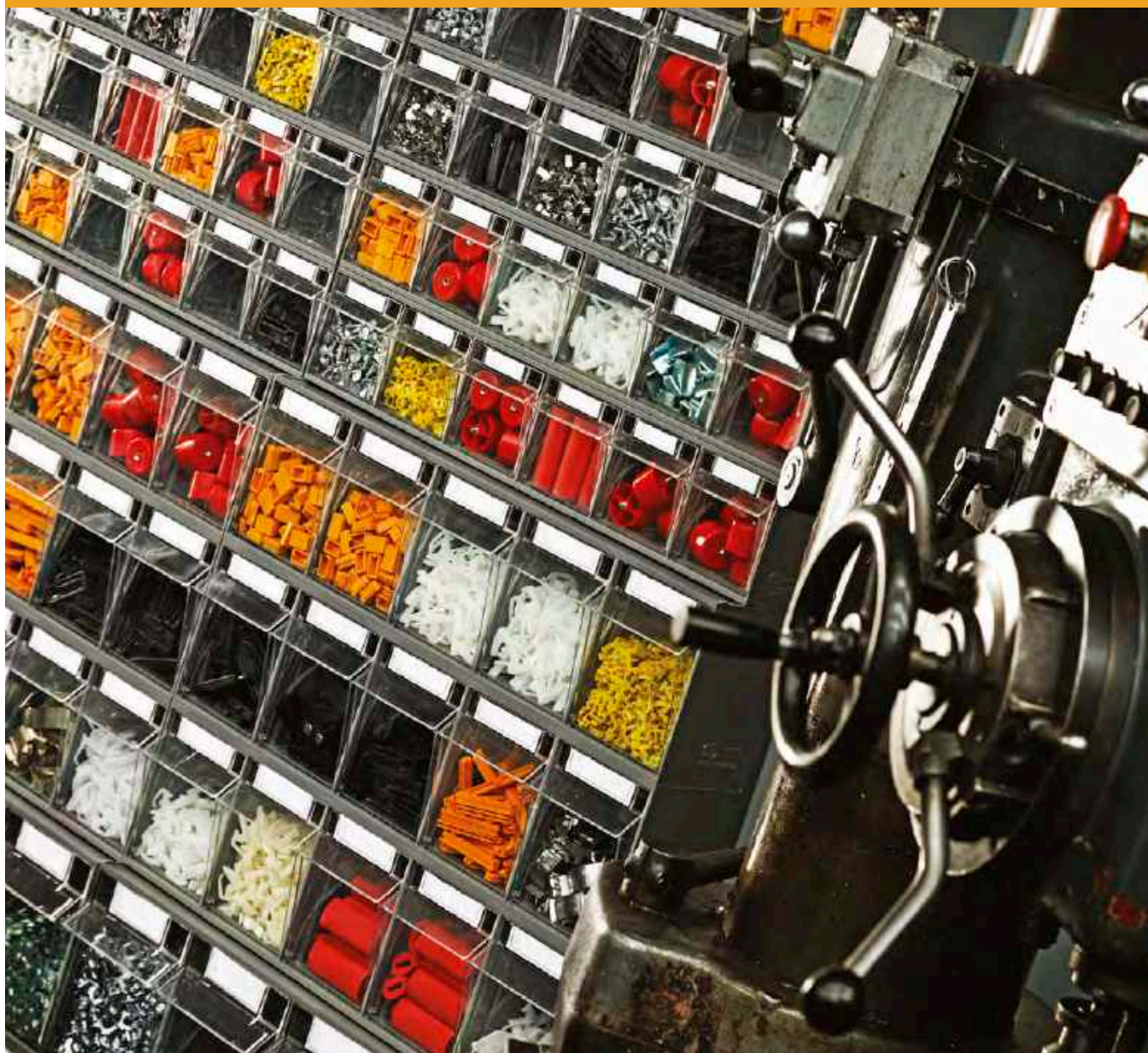
CASSETTE E CONTENITORI IN PLASTICA



POLIPROPILENE



ECOGREEN



ABS



POLISTIROLO



POLIETILENE



300 X 200 MM

ART.	dim. ingombro			dim. utili			L	colore	€
	Lmm	Pmm	Hmm	Lmm	Pmm	Hmm			
FAXEB3212A05101	298	200	120	259	160	116	5	Grigio scuro	5,10
FAXEB3217A05101	298	198	170	259	160	166	7	Grigio scuro	5,40
FAXEB32HG005101	298	192	15	-	-	-	-	Grigio scuro	3,00



400 X 300 MM

ART.	dim. ingombro			dim. utili			L	colore	€
	Lmm	Pmm	Hmm	Lmm	Pmm	Hmm			
FAXEB4312A05101	400	300	120	355	255	116	10	Grigio scuro	6,90
FAXEB4317A05101	400	300	170	355	255	166	15	Grigio scuro	8,70
FAXEB4322A05101	400	300	220	355	255	216	20	Grigio scuro	9,60
FAXEB4332A05101	400	300	325	355	255	321	30	Grigio scuro	13,80
FAXEB43HG005101	400	300	-	-	-	-	-	Grigio scuro	3,90



600X400 MM

ART.	dim. ingombro			dim. utili			L	colore	€
	Lmm	Pmm	Hmm	Lmm	Pmm	Hmm			
FAXEB6412A05101	600	400	120	555	355	116	20	Grigio scuro	11,40
FAXEB6417A05101	600	400	170	555	355	166	30	Grigio scuro	14,10
FAXEB6422A05101	600	400	220	555	355	216	40	Grigio scuro	18,00
FAXEB6428A05101	600	400	280	555	355	276	53	Grigio scuro	21,00



600X400 MM

ART.	dim. ingombro			dim. utili			L	colore	€
	Lmm	Pmm	Hmm	Lmm	Pmm	Hmm			
FAXEB6432A05101	600	400	325	555	355	321	60	Grigio scuro	23,40
FAXEB6443B05101	600	400	430	555	355	426	90	Grigio scuro	30,00
FAXEB64HG005101	600	400	-	-	-	-	-	Grigio scuro	7,50



CARRELLO PER CASSETTE EURO BOX CON BASE IN ACCIAIO CON RUOTE

ART.	Lmm	Pmm	Hmm	KG	ruote			materiale	finitura	€
					1	3	0			
FCP20110299	698	415	870	150	1	3	100	Gomma standard	Zincato	102,00



CARRELLO PER CASSETTE EURO BOX CON BASE IN ACCIAIO CON RUOTE

ART.	Lmm	Pmm	Hmm	KG	ruote			materiale	finitura	€
					1	3	0			
FCP20110199	615	415	165	150	1	3	100	Gomma standard	Zincato	66,00

EURO BOX

POLIPROPILENE



800X600 MM

ART.	dim. ingombro			dim. utili			L	colore	€
	Lmm	Pmm	Hmm	Lmm	Pmm	Hmm			
FAXEB8612C05101	800	600	120	755	555	101	49	Grigio scuro	29,10
FAXEB8617C05101	800	600	170	755	555	151	69	Grigio scuro	31,20
FAXEB8622C05101	800	600	220	755	555	201	90	Grigio scuro	32,40



800X600 MM

ART.	dim. ingombro			dim. utili			L	colore	€
	Lmm	Pmm	Hmm	Lmm	Pmm	Hmm			
FAXEB8632C05101	800	600	325	755	555	306	130	Grigio scuro	36,60
FAXEB8643C05101	800	600	430	755	555	411	175	Grigio scuro	42,30
FAXEB86SE005101	800	600	-	-	-	-	-	Grigio scuro	12,00



KIT RUOTE

ART.	Ø	KG	Hmm	materiale			€
FKRD1002107	100	225	128	Gomma standard	2	2	39,30



KIT VITI PER FISSAGGIO RUOTE SU CASSETTA EURO BOX

ART.	pz. per confezione	€
FVT01380000	16	2,40



RUOTA GIREVOLE



RUOTA GIREVOLE CON FRENO



RUOTA FISSA



ZINCATO



PORTATA



CAPACITÀ



400X300 MM

ART.	dim. ingombro			dim. utili			L	colore	€
	L mm	P mm	H mm	L mm	P mm	H mm			
FAXEB4312A05401	400	300	120	355	255	116	10	Grigio scuro	5,70
FAXEB4317A05401	400	300	170	355	255	166	15	Grigio scuro	7,20
FAXEB4322A05401	400	300	220	355	255	216	20	Grigio scuro	8,10
FAXEB4332A05401	400	300	325	355	255	321	30	Grigio scuro	11,10
FAXEB43HG005401	400	300	-	-	-	-	-	Grigio scuro	3,30



600X400 MM

ART.	dim. ingombro			dim. utili			L	colore	€
	L mm	P mm	H mm	L mm	P mm	H mm			
FAXEB6412A05401	600	400	120	555	355	116	20	Grigio scuro	9,60
FAXEB6417A05401	600	400	170	555	355	166	30	Grigio scuro	11,70
FAXEB6422A05401	600	400	220	555	355	216	40	Grigio scuro	14,40
FAXEB6432A05401	600	400	325	555	355	321	60	Grigio scuro	18,90
FAXEB64HG005401	600	400	-	-	-	-	-	Grigio scuro	6,30

NESTABLE BOX

POLIPROPILENE



600X400 MM

ART.	dim. ingombro			dim. utili			L	colore	€
	Lmm	Pmm	Hmm	Lmm	Pmm	Hmm			
FAXNL6420B05101	600	400	200	453	336	197	32	Grigio scuro	12,00
FAXNL6430B05101	600	400	300	453	336	297	50	Grigio scuro	18,00
FAXNL6440B05101	600	400	400	453	336	397	70	Grigio scuro	22,80
FAXNL64SE005101	600	400	-	-	-	-	-	Grigio scuro	8,40

PICKING BOX

ECOGREEN



ART.	multiplo d'ordine	mis.	dim. ingombro			dim. utili			L	colore	€
			Lmm	Pmm	Hmm	Lmm	Pmm	Hmm			
FAXPBC001A05401	50	1	100	170	75	88	133	65	1	Grigio scuro	0,90
FAXPBC002A05401	54	2	150	230	125	127	191	110	3,8	Grigio scuro	1,80
FAXPBC3A2B05401	21	3A2	210	350	145	180	270	130	9,4	Grigio scuro	4,20
FAXPBC003B05401	15	3	210	350	200	180	270	183	12,5	Grigio scuro	4,80
FAXPBC004B05401	10	4	310	500	200	282	425	183	28	Grigio scuro	9,30

PICKING BOX

POLIPROPILENE



1



2



3A2



3



4A2

ART.	multiplo d'ordine	mis.	dim.ingombro			dim. utili			L	colore	€
			Lmm	Pmm	Hmm	Lmm	Pmm	Hmm			
FAXPBC001A05101	50	1	100	170	75	88	133	65	1	Grigio scuro	1,20
FAXPBC001A05102	50	1	100	170	75	88	133	65	1	Verde	1,20
FAXPBC001A05103	50	1	100	170	75	88	133	65	1	Rosso	1,20
FAXPBC001A05104	50	1	100	170	75	88	133	65	1	Blu	1,20
FAXPBC001A05105	50	1	100	170	75	88	133	65	1	Giallo	1,20
FAXPBC002A05101	54	2	150	230	125	127	191	110	3,8	Grigio scuro	2,10
FAXPBC002A05102	54	2	150	230	125	127	191	110	3,8	Verde	2,10
FAXPBC002A05103	54	2	150	230	125	127	191	110	3,8	Rosso	2,10
FAXPBC002A05104	54	2	150	230	125	127	191	110	3,8	Blu	2,10
FAXPBC002A05105	54	2	150	230	125	127	191	110	3,8	Giallo	2,10
FAXPBC3A2B05101	21	3A2	210	350	145	180	270	130	9,4	Grigio scuro	4,80
FAXPBC3A2B05102	21	3A2	210	350	145	180	270	130	9,4	Verde	4,80
FAXPBC3A2B05103	21	3A2	210	350	145	180	270	130	9,4	Rosso	4,80
FAXPBC3A2B05104	21	3A2	210	350	145	180	270	130	9,4	Blu	4,80
FAXPBC3A2B05105	21	3A2	210	350	145	180	270	130	9,4	Giallo	4,80
FAXPBC003B05101	15	3	210	350	200	180	270	183	12,5	Grigio scuro	5,70
FAXPBC003B05102	15	3	210	350	200	180	270	183	12,5	Verde	5,70
FAXPBC003B05103	15	3	210	350	200	180	270	183	12,5	Rosso	5,70
FAXPBC003B05104	15	3	210	350	200	180	270	183	12,5	Blu	5,70
FAXPBC003B05105	15	3	210	350	200	180	270	183	12,5	Giallo	5,70
FAXPBC4A2B05101	14	4A2	310	500	145	282	425	134	20	Grigio scuro	9,60
FAXPBC4A2B05102	14	4A2	310	500	145	282	425	134	20	Verde	9,60
FAXPBC4A2B05103	14	4A2	310	500	145	282	425	134	20	Rosso	9,60
FAXPBC4A2B05104	14	4A2	310	500	145	282	425	134	20	Blu	9,60
FAXPBC4A2B05105	14	4A2	310	500	145	282	425	134	20	Giallo	9,60

PICKING BOX

POLIPROPILENE



4



4A5



5P4



5

ART.	multiplo d'ordine	mis.	dim.ingombro			dim. utili			L	colore	€
			Lmm	Pmm	Hmm	Lmm	Pmm	Hmm			
FAXPBC004B05101	10	4	310	500	200	282	425	183	28	Grigio scuro	10,80
FAXPBC004B05102	10	4	310	500	200	282	425	183	28	Verde	10,80
FAXPBC004B05103	10	4	310	500	200	282	425	183	28	Rosso	10,80
FAXPBC004B05104	10	4	310	500	200	282	425	183	28	Blu	10,80
FAXPBC004B05105	10	4	310	500	200	282	425	183	28	Giallo	10,80
FAXPBC4A5B05101	6	4A5	310	500	300	282	425	285	42	Grigio scuro	13,20
FAXPBC4A5B05102	6	4A5	310	500	300	282	425	285	42	Verde	13,20
FAXPBC4A5B05103	6	4A5	310	500	300	282	425	285	42	Rosso	13,20
FAXPBC4A5B05104	6	4A5	310	500	300	282	425	285	42	Blu	13,20
FAXPBC4A5B05105	6	4A5	310	500	300	282	425	285	42	Giallo	13,20
FAXPBZ5P4E05101	1	5P4	472	535	300	432	435	281	63	Grigio scuro	24,60
FAXPBZ5P4E05102	1	5P4	472	535	300	432	435	281	63	Verde	24,60
FAXPBZ5P4E05103	1	5P4	472	535	300	432	435	281	63	Rosso	24,60
FAXPBZ5P4E05104	1	5P4	472	535	300	432	435	281	63	Blu	24,60
FAXPBZ5P4E05105	1	5P4	472	535	300	432	435	281	63	Giallo	24,60
FAXPBZ005E05101	1	5	472	720	300	434	615	275	88	Grigio scuro	30,90
FAXPBZ005E05102	1	5	472	720	300	434	615	275	88	Verde	30,90
FAXPBZ005E05103	1	5	472	720	300	434	615	275	88	Rosso	30,90
FAXPBZ005E05104	1	5	472	720	300	434	615	275	88	Blu	30,90
FAXPBZ005E05105	1	5	472	720	300	434	615	275	88	Giallo	30,90



DIVISORIO LONGITUDINALE IN PLASTICA

ART.	multiplo d'ordine	per contenitore mis.	Lmm	Hmm	colore	€
FAXPBDC3A207107	10	3A2	300	105	Nero	2,10
FAXPBDC00307107	10	3	305	160	Nero	2,70
FAXPBDC00407107	10	4	460	160	Nero	3,60



ART.	multiplo d'ordine	dim.ingombro			cassetti				colore	€
		Lmm	Pmm	Hmm	n.	Lmm	Pmm	Hmm		
FAXVBCH00900001	2	600	69	77	9	59	44	49	Grigio scuro	13,20
FAXVBCH00600001	2	600	98	112	6	87	66	72	Grigio scuro	16,20
FAXVBCH00500001	1	600	141	164	5	113	100	110	Grigio scuro	25,50
FAXVBCH00400001	1	600	174	206	4	142	130	135	Grigio scuro	33,60
FAXVBCH00300001	1	600	209	240	3	190	146	164	Grigio scuro	39,30
FAXVBCH00200001	1	600	311	353	2	285	219	246	Grigio scuro	73,50

FERMO PER CASSETTIERA VISUAL BOX

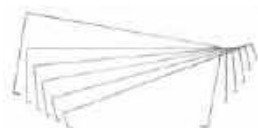

ART.	adatto per	€
FAXVBCHL0900099	FAXVBCH009000	1,80
FAXVBCHL0600099	FAXVBCH006000	1,80
FAXVBCHL0500099	FAXVBCH005000	1,50
FAXVBCHL0400099	FAXVBCH004000	1,80
FAXVBCHL0300099	FAXVBCH003000	1,80
FAXVBCHL0200099	FAXVBCH002000	1,80



SCAFFALE VUOTO DA PARETE PER CASSETTIERE VISUAL BOX

ART.	Lmm	Pmm	Hmm	RAL	€
FVBSW1500000001	604	41	1502	7000	34,80
FVBSW1950000001	604	41	1952	7000	38,10



BASE PER SCAFFALE VISUAL BOX

ART.	Lmm	Pmm	Hmm	RAL	€
FVBSBASE00000001	600	300	100	7000	32,40



MAT

POLIETILENE

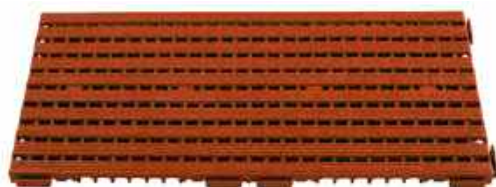

TAPPETO ANTISDRUCCIOLO IN POLIETILENE

ART.	Lmm	Pmm	Hmm	colore	€
FAXSMTC08004001	800	400	25	Grigio scuro	15,60
FAXSMTC08004006	800	400	25	Rosso mattone	15,60

TAPPETO ANTISDRUCCIOLO FORATO IN POLIETILENE

ART.	Lmm	Pmm	Hmm	colore	€
FAXSMTA08004001	800	400	25	Grigio scuro	14,40
FAXSMTA08004006	800	400	25	Rosso mattone	14,40



RACCORDO PER TAPPETO IN POLIETILENE

ART.	Lmm	Pmm	Hmm	colore	€
FAXSMRC04001205	400	120	25	Giallo	3,60

ANGOLO PER TAPPETO IN POLIETILENE

ART.	Lmm	Pmm	Hmm	colore	€
FAXSMAN01201205	120	120	25	Giallo	2,10



CLIP PER AGGANCIOTAPPETO

ART.	Pmm	Hmm	finitura	€
FAXSMCL00000099	10	14	Zincato	0,30



ZINCATO



RAL 7000







MSD 10

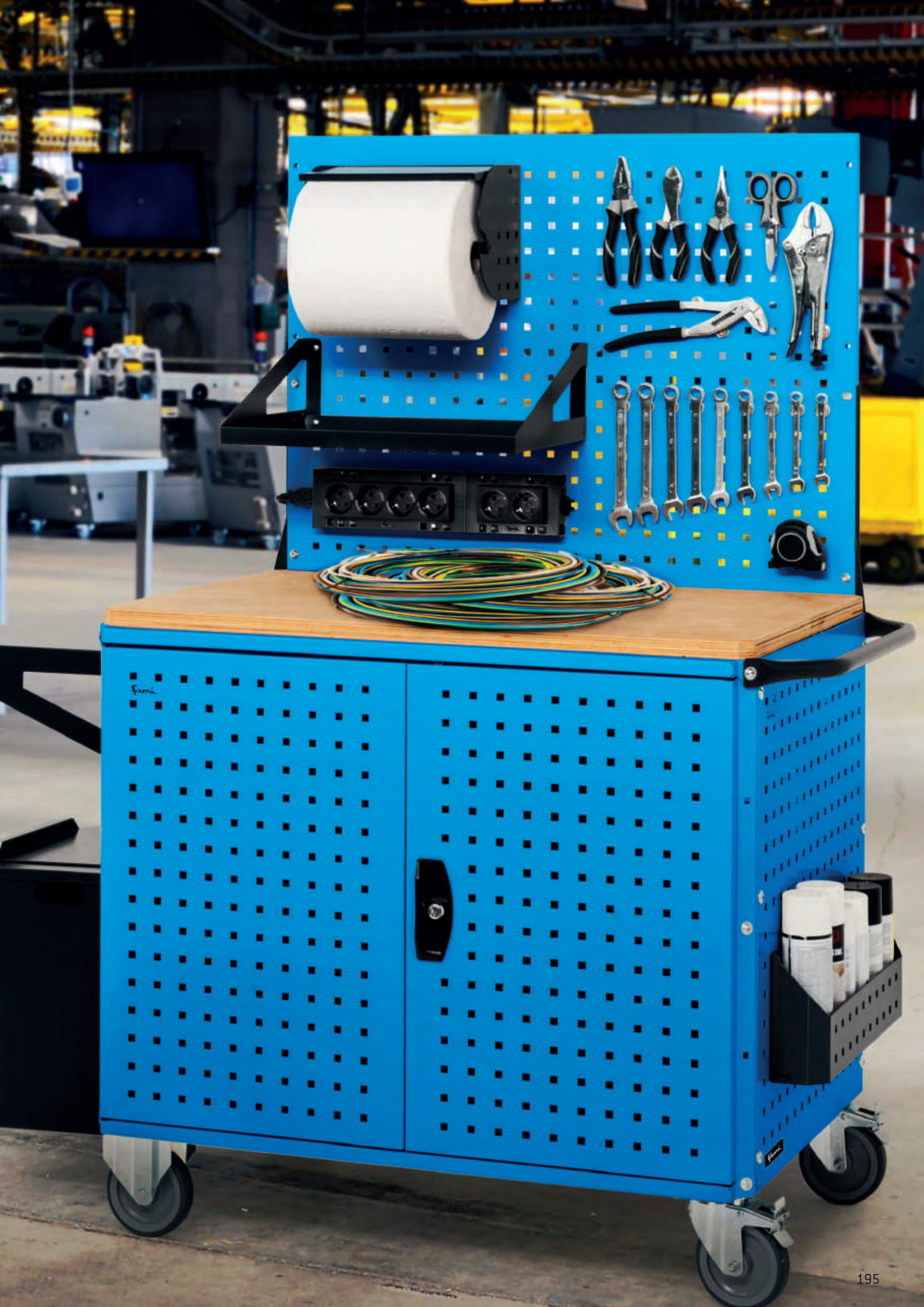

Ferni

FAMI SHOP

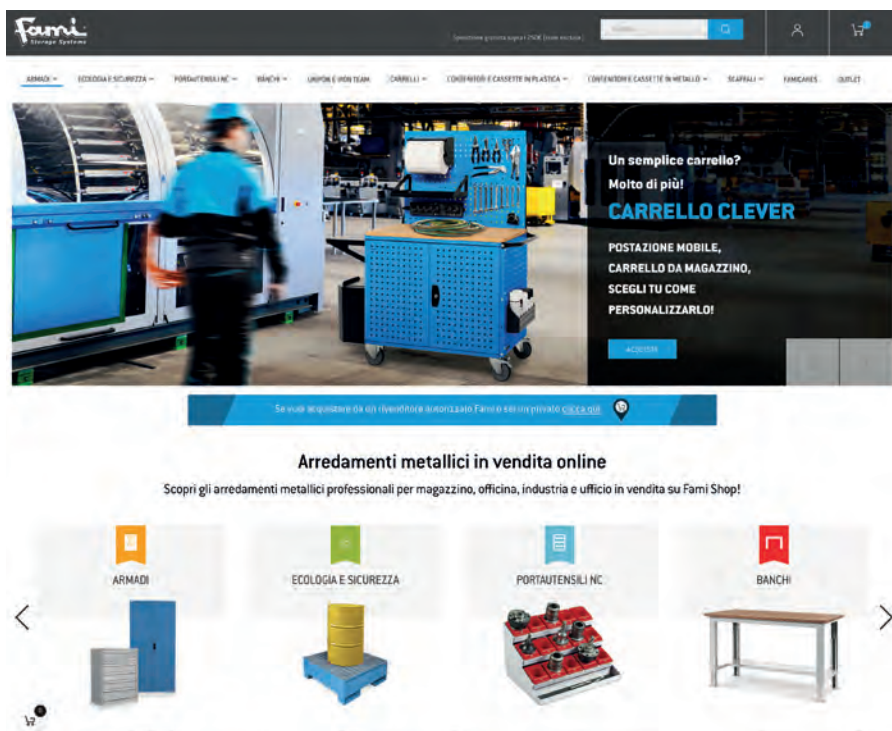

È ARRIVATO FAMI SHOP! L'E-COMMERCE SVILUPPATO PER I NOSTRI PARTNERS

+ 300 PRODOTTI

Su Fami Shop puoi trovare una vasta gamma di prodotti Fami Ideaone per arredare le diverse aree della tua azienda!

PRONTA CONSEGNA

Conoscenza immediata della disponibilità:

>10 giorni lavorativi indicati in VERDE

>20 giorni lavorativi indicati in ROSSO

FACILITÀ DI ACQUISTO

Registrati, scegli il prodotto e la quantità e aggiungi gli articoli alla tua lista dei desideri o al carrello per acquistarli subito.

CONSEGNA GRATUITA

La **consegna è gratuita per gli ordini superiori a 250,00 €**. Per ordini di importo inferiore, i costi di spedizione sono pari a 30,00 €.

È online il nuovo configuratore 3D

Combina i diversi elementi e componenti online per realizzare il banco, il carrello, l'armadio perfetto per le tue necessità con il configuratore di Fami!

Innovativo, facile da utilizzare ed unico nel suo genere il planner ti consente di:

- Progettare il tuo arredo in 12 colori diversi
- Creare il tuo profilo personale in cui salvare i tuoi progetti
- Inserire i progetti creati nel carrello di Fami Shop
- Conoscere in qualsiasi momento i prezzi (aggiornati in tempo reale)

Visita il sito e inizia a ideare tutte le soluzioni che vuoi per allestire le diverse aree della tua azienda!

Online trovi l'elenco dei Paesi in cui è disponibile il configuratore 3D. Scopri la lista in continuo aggiornamento!

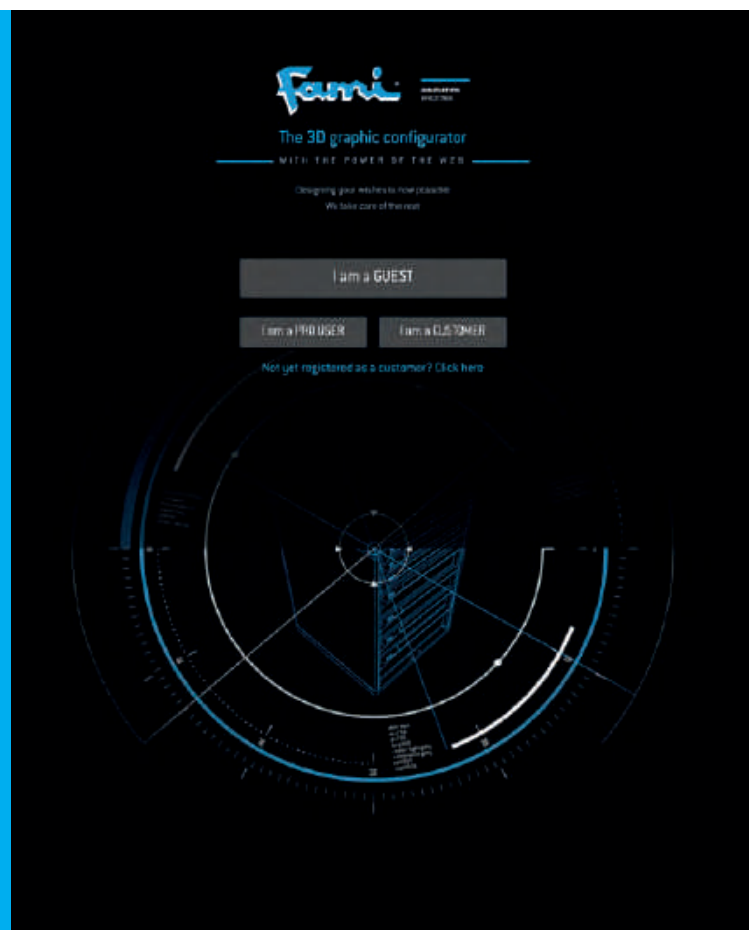

CONDIZIONI GENERALI DI GARANZIA

Gentile Cliente,

ogni acquisto di prodotti di Fami S.r.l. è accompagnato da una garanzia convenzionale (la "Garanzia"), disciplinata in conformità alle modalità ed ai termini qui di seguito indicati.

1. PREMESSE:

Nelle Condizioni che seguono, i termini sotto indicati avranno il seguente significato:

a) Venditore: Fami S.r.l.

b) Acquirente: qualunque soggetto (persona fisica, società, ente, entità giuridica) che acquisti i Prodotti del Venditore;

c) Prodotto/i: i beni fabbricati, assemblati e/o commercializzati dal Venditore, esclusi i Prodotti a marchio Store Van;

2. OGGETTO DELLA GARANZIA

2.1 Fami S.r.l. garantisce che i Prodotti sono esenti da vizi e conformi alle specifiche tecniche dichiarate dal Venditore.

2.2 Resta inteso che le dimensioni dei Prodotti sono da intendersi tenendo conto dei margini di tolleranza d'uso nel commercio con riferimento al tipo, quantità, qualità dei Prodotti. Il Venditore, pertanto, non garantisce la rispondenza dei Prodotti a particolari specifiche o caratteristiche tecniche o la loro idoneità ad usi particolari diversi rispetto a quelle indicate nelle specifiche tecniche dichiarate da Fami S.r.l. e previste nel manuale d'uso e manutenzione, se non nella misura in cui tali caratteristiche siano state espressamente convenute nel contratto di vendita.

2.3 Qualora venga segnalata dal Cliente ed accertata la presenza di difetti sui Prodotti, il Cliente avrà diritto alla loro riparazione gratuita ovvero, qualora la riparazione risulti impossibile o eccessivamente onerosa, alla sostituzione gratuita del Prodotto, ad insindacabile giudizio del Venditore, con esclusione di ogni ulteriore e diversa obbligazione in capo a Fami S.r.l..

2.4 La Garanzia non pregiudica, e rimangono quindi salvi, i diritti previsti nel Decreto Legislativo 6.9.2005 n. 206 e successive modifiche ed integrazioni (il "Codice del Consumo"), nel caso in cui il Cliente sia qualificabile come "consumatore".

3. CONDIZIONI DI OPERATIVITÀ DELLA GARANZIA

3.1 Ai fini dell'attivazione della Garanzia, il Cliente avrà l'onere di informare Fami S.r.l., nei limiti temporali di cui agli articoli 4 e 5 che seguono, della scoperta di difetti tramite una segnalazione (la "Segnalazione") avente i contenuti indicati nel seguente articolo 5.

3.2 Il Cliente, fatta la Segnalazione, dovrà interrompere immediatamente l'utilizzo del/i Prodotto/i difettoso/i.

3.3 A seguito della ricezione della Segnalazione, il Venditore porrà in essere quanto necessario per accertare l'esistenza, la natura e la consistenza dei difetti e per verificare la tempestività della Segnalazione ai sensi del seguente articolo 5. A tali scopi il Cliente sarà tenuto a rendere disponibile/i il Prodotto/i difettoso/i per la loro ispezione anche tramite l'invio di documentazione fotografica ovvero l'utilizzo di sistemi di videoconferenza. Il Prodotto verrà riparato dal Venditore presso la propria sede, la propria filiale, o presso un proprio rivenditore autorizzato. Il Venditore si riserva la facoltà di riparare il Prodotto presso il Cliente. Qualora sia necessario, il Cliente dovrà provvedere ad inviare a proprie spese il Prodotto difettoso presso uno dei predetti luoghi, così come indicato dal Venditore, fatte salve le norme del Codice del Consumo. Il Venditore trasmetterà al Cliente il nuovo Prodotto o il Prodotto riparato, sostenendo i costi di spedizione.

3.4 La riparazione di un Prodotto difettoso sarà effettuata in tempi congrui rispetto all'entità del difetto.

4. DURATA – PERIODO DI COPERTURA

4.1 La durata della Garanzia per i Prodotti è di 10 anni che decorre dalla data di consegna dei Prodotti, salvo che si tratti di Prodotti commercializzati, componenti elettronici, software e le parti di usura, per i quali viene prevista una garanzia di 12 mesi che decorre, sempre, dalla data di consegna degli stessi. Si precisa che per "data di consegna" si intende la data in cui i Prodotti hanno lasciato i magazzini di Fami S.r.l. per essere consegnati al Cliente, salva diversa previsione nel contratto di vendita.

4.2 Per i Prodotti riparati o sostituiti, la garanzia decorre nuovamente ed ha una durata di 12 mesi dalla riparazione oppure dalla sostituzione. Complessivamente, pertanto, la durata della Garanzia per Prodotti riparati o sostituiti dal Venditore è di massimo 11 anni ovvero, per i Prodotti commercializzati, componenti elettronici, software e le parti di usura, di massimo 24 mesi dall'inizio della durata della Garanzia di cui al precedente articolo 4.1.

4.3 Alla scadenza del termine di cui al precedente articolo 4.1, il diritto di regresso previsto dall'art. 131 del Codice del Consumo, qualora esso sia applicabile, dovrà intendersi come prescritto ed inammissibile.

5. TEMPI E MODI DELLA SEGNALEZIONE

5.1 Durante il periodo di vigenza della Garanzia, eventuali reclami relativi allo stato dell'imballo, quantità, numero o alle caratteristiche esteriori dei Prodotti (vizi e difetti non occulti e visibili dall'esterno), dovranno essere annotati dal Cliente sulla bolla di consegna, firmando il D.D.T. indicando la dicitura "riserva specifica". Entro e non oltre 2 (due) giorni lavorativi dalla data di ricevimento dei Prodotti, il Cliente dovrà inviare al Venditore, tramite messaggio di posta elettronica al seguente indirizzo assistance@famisp.it, copia della bolla di consegna e relativo rilievo fotografico, fornendo informazioni dettagliate sulle condizioni dei Prodotti e sulla natura dei difetti rilevati.

5.2 Eventuali reclami relativi a difetti non individuabili mediante un diligente controllo al momento del ricevimento (vizi occulti) dovranno essere notificati al Venditore, a pena di decadenza, entro e non oltre 7 (sette) giorni dalla data della scoperta del difetto, tramite messaggio di posta elettronica certificata al seguente indirizzo pec@pec.famisp.it, specificando con precisione il codice prodotto, il lotto (se disponibile), la data di consegna e la natura del difetto.

6. ESCLUSIONI E LIMITAZIONE DELLA RESPONSABILITÀ

6.1 La garanzia non opera con riferimento a Prodotti i cui difetti sono dovuti a: a) operazioni di trasporto; b) mancato rispetto di accorgimenti rientranti nell'ordinaria prassi di manutenzione; negligenza e trascuratezza nell'uso; c) mancata osservanza delle istruzioni fornite dal Venditore per l'utilizzo e/o lo stoccaggio del Prodotto; d) mancato rispetto delle norme d'installazione e/o di ogni altra indicazione o istruzione riportata sulle note tecniche a corredo del Prodotto qualora l'installazione non sia stata curata direttamente dal Venditore; e) manomissioni, manutenzioni in genere, interventi operati al Cliente o da personale non autorizzato dal Venditore; f) uso anomalo e/o improprio del Prodotto, collocazione dello stesso in locali umidi, eccessivamente caldi o freddi, polverosi o aggressivi (presenza di cloro, lacche, vernici o altri agenti chimici e/o tossici) o comunque in locali non idonei alla corretta conservazione dei Prodotti nei limiti in cui tali circostanze non siano state documentate al Venditore prima dell'acquisto dei Prodotti ed il Venditore abbia garantito la tollerabilità dei Prodotti a tali ambienti; g) aggravio dei danni causato dall'utilizzo dei Prodotti da parte del Cliente una volta che si siano manifestati i difetti; h) utilizzo di parti di ricambio, componenti ed accessori non originali o non consigliati dal Venditore (non può essere richiesta la sostituzione o la riparazione di pezzi non originali) e danni provocati al Prodotto dall'uso degli stessi; i) anomalie o difettoso funzionamento dell'alimentazione elettrica;

l) corrosioni, incrostazioni o rotture provocate da correnti vaganti, condense, aggressività o acidità dell'acqua, trattamenti disincrostanti effettuati impropriamente, depositi di fanghi o calcare; m) caso fortuito, cause di forza maggiore quali, a titolo esemplificativo e non esaustivo, gelo, surriscaldamento, incendio, furto, eventi naturali (come ad esempio, grandine, trombe d'aria, fulmini, inondazioni, terremoti), atti vandalici, incidenti e altri simili avvenimenti.

6.2 La Garanzia non opera se il prezzo di vendita dei Prodotti non è stato interamente saldato, con la precisazione che qualora il pagamento sia previsto in più scadenze, la Garanzia sarà da subito operativa e rimarrà tale fino a quando le scadenze di pagamento resteranno tempestivamente onorate.

6.3 Il Venditore non è responsabile per eventuali danni che possano, direttamente o indirettamente, derivare a persone, cose o animali, in conseguenza della mancata osservanza di tutte le prescrizioni indicate nel libretto di installazione, uso e manutenzione.

6.4 Il Venditore declina ogni responsabilità relativa a danni indiretti causati dalla difettosità di un Prodotto come, a titolo puramente indicativo ma non esaustivo, il fermo di produzione ovvero la mancata spedizione o cessione a terzi del Prodotto.

6.5 In ogni caso, la responsabilità del Venditore non potrà comunque eccedere il prezzo pagato dal Cliente per il singolo contratto di vendita dal cui contenuto è derivata la fattispecie inerente all'eventuale richiesta di danno e/o risarcimento.

6.6 I Prodotti dovranno essere utilizzati solo ed esclusivamente per gli scopi indicati e nel rispetto delle normative sulla sicurezza, conformemente alle previsioni del manuale di installazione, uso e manutenzione fornito dal Venditore; nel caso in cui il Cliente dovesse utilizzare o rivendere i Prodotti acquistati e/o Prodotti dal Venditore per scopi diversi, lo fa a proprio esclusivo rischio e pericolo, con ogni conseguente responsabilità. In tal caso, è esclusa la responsabilità contrattuale e/o extracontrattuale del Venditore per eventuali danni diretti ed indiretti subiti anche da terzi, nonché in caso di cattiva manutenzione, utilizzo improprio, non osservanza di norme di sicurezza ed altre ipotesi e il Cliente dovrà tenere il Venditore indenne da costi e/o responsabilità che potrebbero derivare a suo carico.

7. FORO COMPETENTE E LEGGE APPLICABILE

7.1 Per qualunque controversia derivante o connessa alle presenti Condizioni Generali di Garanzia quali, a titolo meramente esemplificativo e non esaustivo, controversie relative alla loro esistenza, validità, interpretazione, efficacia, esecuzione, è competente a decidere in via esclusiva il Tribunale di Vicenza, anche qualora il Contratto presenti elementi di internazionalità, fatte salve le norme inderogabili del Codice del Consumo.

7.2 Le presenti Condizioni Generali di Garanzia sono interamente soggetti alla legge italiana e interpretati secondo la stessa, anche qualora il Contratto presenti elementi di internazionalità, con espressa esclusione della Convenzione di Vienna del 1980.

CONDIZIONI GENERALI DI VENDITA

1. Definizioni

1.1 Nel contesto delle presenti Condizioni, i termini di seguito indicati avranno il seguente significato:

- a) Venditore: Fami S.r.l.
- b) Acquirente: qualunque società, ente, entità giuridica che acquisti i Prodotti del Venditore;
- c) Prodotti: i beni fabbricati, assemblati e/o commercializzati dal Venditore;
- d) Ordine: ciascuna proposta di acquisto dei Prodotti inoltrata dall'Acquirente al Venditore;
- e) Conferma d'Ordine: l'accettazione scritta dell'Ordine da parte del Venditore;
- f) Contratto: la vendita conclusa tra il Venditore e l'Acquirente a seguito del ricevimento da parte dell'Acquirente della Conferma d'Ordine.
- g) Parti: il Venditore e l'Acquirente congiuntamente;
- h) Marchi: tutti i marchi di cui il Venditore è proprietario o licenziatario;
- i) Diritti di Proprietà Intellettuale: tutti i diritti di proprietà intellettuale e/o industriale di Fami S.r.l., ivi inclusi, senza limitazione alcuna, i diritti relativi a: brevetti per invenzioni, disegni o modelli, modelli di utilità, Marchi, know-how, specifiche tecniche, dati, software, indipendentemente dalla registrazione o meno di tali diritti, nonché qualsivoglia domanda o registrazione relativa a tali diritti ed ad ogni altro diritto o forma di protezione di natura similare o avente effetto equivalente.

2. Disposizioni Generali

- 2.1 Le presenti Condizioni Generali di Vendita (di seguito, le "Condizioni") formano parte integrante dei Contratti conclusi tra il Venditore e l'Acquirente per la fornitura dei Prodotti.
- 2.2 Le Condizioni si applicano tra Fami S.r.l. (di seguito, "Fami") e l'Acquirente senza la necessità che vi sia un espresso richiamo alle stesse o uno specifico accordo in tal senso. Qualsiasi condizione o termine differente trova applicazione soltanto se confermato per iscritto da parte del Venditore.
- 2.3 Il Venditore si riserva il diritto di modificare, integrare o eliminare qualsiasi previsione delle presenti Condizioni Generali di Vendita, in qualsiasi momento, dandone notizia anche tramite la pagina a ciò dedicata del sito aziendale, restando inteso che tali aggiunte, modifiche o cancellazioni si applicheranno a tutte le Vendite concluse a partire dal 15° giorno successivo alla comunicazione (tramite pubblicazione sul sito web oppure tramite invio di newsletter o qualsivoglia corrispondenza inviata per iscritto) all'Acquirente delle nuove Condizioni di Vendita.
- 2.4 Qualsiasi riferimento a termini commerciali (come EXW, DPA, DPU, DDP, etc.) è da intendersi come richiamo agli Incoterms® della Camera di Commercio Internazionale, nel testo in vigore alla data di stipulazione del Contratto.

3. Ambito di applicazione

- 3.1 Le presenti Condizioni Generali di Vendita (di seguito, le "Condizioni") si applicano a tutti i Contratti (sia essi conclusi telefonicamente, a mezzo telefax, e-mail o sito internet), ove non espressamente derogate per iscritto dalle Parti e formano parte integrante e sostanziale di ogni Ordine, Conferma d'Ordine, anche se non espressamente citate.
- 3.2 L'Acquirente non può invocare né eccepire condizioni diverse dalle presenti Condizioni. Pertanto, non hanno alcuna validità le eventuali condizioni precisate per iscritto dall'Acquirente sull'Ordine, ovvero in qualsiasi altra fase della trattativa contrattuale nonché successivamente alla Conferma d'Ordine, così come le eventuali condizioni generali di acquisto dell'Acquirente stesso. Qualsiasi condizione scritta o verbale inviata da parte di collaboratori, dipendenti, agenti o rappresentanti del Venditore è priva di valore se non riprodotta nel testo della Conferma d'Ordine o se non confermata per iscritto dal Venditore. In tal senso, l'esecuzione, anche parziale, dell'Ordine da parte di Fami od ogni altro suo adempimento nei confronti dell'Acquirente non valgono e non possono essere interpretati come tacita o implicita accettazione di qualsivoglia condizione generale di contratto che non sia stata espressamente sottoscritta da Fami.
- 3.3 Le Condizioni sono valide esclusivamente per rapporti contrattuali tra Fami e operatori professionali, per cui non troverà alcuna applicazione il D.Lgs. 6 settembre 2005, n. 206 (Codice del Consumo) e successive modifiche.

4. Offerte e Ordini

- 4.1 Le offerte del Venditore non sono da considerarsi vincolanti. Le indicazioni riportate su cataloghi, prospetti e listini non impegnano il Venditore, che si riserva la facoltà di apportare qualsiasi modifica ai Prodotti ed ai relativi prezzi; pertanto, il Venditore si considera vincolato esclusivamente da quanto riportato nella Conferma d'Ordine.
- 4.2 Ciascun Ordine inviato dall'Acquirente, sia direttamente a Fami sia per il tramite degli agenti o dei rappresentanti del Venditore, è da intendersi come una proposta irrevocabile d'acquisto, destinata a rimanere efficace per 30 (trenta) giorni, decorrenti dalla data della sua regolare ricezione da parte del Venditore, salvo esplicita deroga indicata di volta in volta.
- 4.3 L'invio dell'Ordine da parte dell'Acquirente implica l'integrale presa visione e la conoscenza da parte dello stesso di tutte le presenti Condizioni, le quali dovranno quindi intendersi integralmente accettate dall'Acquirente senza limitazioni e riserve.
- 4.4 Gli Ordini e/o le eventuali modifiche degli Ordini effettuati verbalmente o telefonicamente devono essere confermati per iscritto da parte dell'Acquirente. In caso contrario, il Venditore non si assume alcuna responsabilità con riguardo ad eventuali errori o possibili fraintendimenti.
- 4.5 Il Venditore si riserva espressamente di valutare ogni Ordine, non essendo vincolato alla loro accettazione.
- 4.6 Gli Ordini regolarmente accettati dal Venditore mediante Conferma d'Ordine non potranno essere annullati dal Compratore senza il consenso scritto del Venditore.

5. Conclusione del Contratto

- 5.1 Il Contratto potrà dirsi concluso solo a seguito dell'invio di una Conferma d'Ordine da parte di Fami (via e-mail, telefax o altri mezzi telematici equipollenti), con riferimento ad ogni singolo Ordine. In ogni caso, l'emissione della fattura da parte del Venditore oppure l'esecuzione dell'Ordine da parte del Venditore sarà considerata quale conferma.
- 5.2 Qualora la Conferma d'Ordine contenga aggiunte, limitazioni o altre variazioni rispetto all'Ordine, l'assenso dell'Acquirente a tali variazioni si intenderà tacitamente prestato salvo contestazione scritta da far pervenire per iscritto al Venditore entro 2 giorni lavorativi dal ricevimento della stessa.
- 5.3 Modifiche e integrazioni richieste dall'Acquirente successivamente alla conclusione del Contratto non avranno valore ed efficacia se non accettate per iscritto da parte del Venditore, con l'eventuale precisazione dei nuovi termini di consegna, del prezzo e delle modalità di pagamento.
- 5.4 Tutti i Contratti si intendono sempre conclusi presso la sede legale di Fami S.r.l. in Italia, 36027 Rosà (Vi), Via Stazione Rossano n. 13

6. Prezzi

- 6.1 I prezzi dei Prodotti saranno quelli indicati nel listino prezzi del Venditore in vigore al momento della conclusione dell'Ordine o, qualora il Prodotto non sia inserito nel listino prezzi o il listino prezzi non sia disponibile, quelli indicati nella Conferma d'Ordine.
- 6.2 I prezzi dei Prodotti saranno quelli indicati nella Conferma d'Ordine e, salvo patto contrario, si intendono per merce resa franco fabbrica [EXW]. Tali prezzi, fatta salva diversa indicazione nella Conferma d'Ordine, non comprendono i costi e le spese di imballaggi speciali, spedizione, assicurazione e trasporto dai locali del Venditore, ogni spesa, tassa o imposta inerente alla vendita dei Prodotti, inclusi i costi di tutte le formalità doganali [a titolo esemplificativo e non esaustivo: dazi, tasse ed altri oneri per l'esportazione dei Prodotti], che restano a carico dell'Acquirente.
- 6.3 Il Venditore si riserva il diritto di effettuare un adeguamento del prezzo nel caso di modifica [a] del Contratto, richiesto dall'Acquirente successivamente alla conclusione dello stesso ed accettato dal Venditore e [b] del tipo della fornitura, del materiale o dell'esecuzione dei Prodotti dovuti all'incompletezza ovvero alla non correttezza delle informazioni e/o della documentazione fornita dall'Acquirente.

7. Termini di pagamento

- 7.1 Al momento della conclusione del contratto, il Venditore potrà richiedere all'Acquirente il versamento di una caparra confirmatoria pari al 30% del valore della fornitura. Le Parti in ogni caso possono pattuire il versamento di una caparra confirmatoria diversa previo accordo per iscritto nel Contratto.
- 7.2 In caso di mancato versamento della caparra confirmatoria, ove prevista, il Contratto si intende risolto ipso iure ed il Venditore potrà richiedere il pagamento delle somme sin a quel momento maturate, oltre al risarcimento di tutti i danni patrimoniali e non patrimoniali, nonché le spese, anche legali, eventualmente sostenute.
- 7.3 Ove nel Contratto non vengano precisate le condizioni di pagamento, esso dovrà essere effettuato a 30 gg. data fattura fine mese, mediante bonifico bancario. Il pagamento si considera effettuato quando la somma entra nella disponibilità del Venditore presso la sua Banca in Italia. Ove le Parti abbiano pattuito il pagamento anticipato senza ulteriori indicazioni, si presume che il pagamento anticipato si riferisca all'intero prezzo dei Prodotti inclusi nella fornitura. In caso di consegna ripartita in più soluzioni, l'acquirente dovrà, per ognuna di esse, versare l'importo corrispondente alla merce consegnata, salvo diverso accordo scritto previsto nel Contratto.
- 7.4 I pagamenti devono essere effettuati nella valuta concordata ed eventuali spese o commissioni bancarie dovute in relazione al pagamento saranno integralmente a carico dell'Acquirente.
- 7.5 In caso di mancato o ritardato pagamento, anche parziale, da parte dell'Acquirente, il Venditore, salvi tutti gli altri suoi diritti, avrà facoltà di sospendere le ulteriori consegne anche se queste fossero dovute in dipendenza di altri contratti e richiedere l'immediato ed integrale pagamento di tutto il materiale ordinato nonché di differire le proprie consegne per un termine pari al ritardo nei pagamenti, qualunque ne sia l'importo e ciò sino al saldo di tali pagamento e dei relativi interessi moratori.
- 7.6 Sui mancati e ritardati pagamenti il Venditore ha diritto al riconoscimento e al pagamento a suo favore degli interessi di mora ex D.Lgs. 231/2002, oltre alle spese, anche legali, che dovessero ritenersi necessarie per il recupero delle somme a qualsiasi titolo spettanti al Venditore.
- 7.7 Il mancato pagamento anche di una sola fattura comporterà per il Venditore il diritto di risolvere ogni Contratto in essere con l'Acquirente ai sensi dell'art. 1456 c.c. e di sospendere l'evasione o la consegna di ogni altra fornitura in corso di esecuzione, salvo in ogni caso il risarcimento integrale del danno conseguito dall'inadempimento o dal ritardo dell'Acquirente. Eventuali ritardi nell'evasione degli Ordini o nelle consegne causati da precedenti sospensioni della produzione per mancati pagamenti dell'Acquirente non costituiranno inadempimento del Venditore.
- 7.8 Qualsiasi reclamo o contestazione non darà diritto all'Acquirente di sospendere o ritardare i pagamenti.

8. Termini di consegna

- 8.1 Il termine di consegna sarà quella indicati nella Conferma d'Ordine e, salvo patto contrario, si intende stabilita ex-works [EXW] presso lo stabilimento del Venditore. Se richiesto ed espressamente pattuito per iscritto nel Contratto, Fami si occuperà del trasporto dei Prodotti a rischio, costi e spese dell'Acquirente. Le eventuali spese di trasposto saranno a carico dell'Acquirente e ciò non inciderà

in alcun modo sui rischi della spedizione che resteranno anche essi in capo all'Acquirente al più tardi con la consegna dei Prodotti al primo trasportatore.

8.2. La consegna dei Prodotti dovrà avvenire entro il termine indicato nel Contratto, computato in giorni lavorativi, precisato peraltro che i termini di consegna restano puramente indicativi e non sono termini essenziali e, in ogni caso, non includono i tempi di trasporto. Il Venditore, quindi, non risponderà del ritardo nella consegna per alcun motivo.

8.3. Qualora l'Acquirente richieda al Venditore una variazione del termine di consegna, dovrà effettuare la relativa richiesta per iscritto e procedere comunque al saldo della fornitura entro i termini indicati nell'articolo 7 delle presenti Condizioni. Restano esclusi i soli eventuali costi di custodia, consegna, montaggio, smontaggio e installazione, i quali dovranno essere saldati entro la nuova data di consegna pattuita.

8.4. Dal ricevimento dell'avviso di merce pronta l'Acquirente dovrà ritirare la merce nel termine massimo di 10 (dieci) giorni. In difetto, i Prodotti potranno essere stoccati all'aperto, con esonero del Venditore da ogni responsabilità e decadenza, a beneficio di quest'ultima, di tutte le garanzie e con addebito all'Acquirente dei costi di movimentazione e magazzinaggio, nonché di ogni altra eventuale spesa, sostenuti dal Venditore, che altresì si riserva la facoltà di far depositare la merce a spese dell'Acquirente.

8.5 Entro 10 (dieci) giorni dall'avviso di merce pronta il Venditore avrà la facoltà di emettere regolare fattura.

8.6 In caso di ritardo nel ritiro della merce, comunque approntata, per una qualsiasi ragione non dipendente dalla volontà del Venditore, la consegna si intenderà comunque come eseguita decorsi dieci giorni dalla comunicazione dell'avviso di merce pronta. In tal caso il Venditore avrà il diritto di procedere alla fatturazione e di reclamare l'adempimento delle condizioni di pagamento pattuite e potrà far effettuare l'imballaggio, il trasporto o lo stoccaggio della merce a spese dell'Acquirente, salvo il risarcimento dei danni eventualmente patiti, anche per l'immagazzinamento, la custodia ed il deposito della merce.

9. Garanzia e Reclami

9.1. La regolamentazione sulla Garanzia offerta dal Venditore è contenuta nel documento Condizioni Generali di Garanzia visionabile sul sito www.famispaspa.com e, per quanto riguarda esclusivamente i Prodotti a marchio Store Van, nel documento Condizioni Generali di Garanzia visionabile sul sito www.storevan.com.

9.2 Al momento della presa in consegna dei Prodotti, l'Acquirente è tenuto ad esaminare i Prodotti alla presenza del trasportatore incaricato della consegna per verificare l'eventuale presenza di difetti visibili dall'esterno (a titolo esemplificativo e non esaustivo, le quantità e l'imballaggio dei Prodotti, la conformità dei Prodotti rispetto a quanto indicato nella Conferma d'Ordine).

9.3 Eventuali reclami relativi allo stato dell'imballo, quantità, numero o alle caratteristiche esteriori dei Prodotti (vizi e difetti non occulti e visibili dall'esterno), dovranno essere annotati dall'Acquirente sulla bolla di consegna, firmando il D.D.T. indicando la dicitura "riserva specifica". Entro e non oltre 2 (due) giorni lavorativi dalla data di ricevimento dei Prodotti, l'Acquirente dovrà inviare al Venditore, tramite messaggio di posta elettronica al seguente indirizzo assistance@famispaspa.it, copia della bolla di consegna e relativo rilievo fotografico, fornendo informazioni dettagliate sulle condizioni dei Prodotti e sulla natura dei difetti rilevati.

9.4 Fatti salvi i termini di durata della Garanzia offerta dal Venditore, eventuali reclami relativi a difetti non individuabili mediante un diligente controllo al momento della presa in consegna dei Prodotti (vizi e difetti occulti) dovranno essere notificati al Venditore, a pena di decadenza, entro e non oltre 7 (sette) giorni dalla data della scoperta del difetto, tramite messaggio di posta elettronica certificata al seguente indirizzo pec@pec.famispaspa.it, specificando il codice prodotto, il lotto (se disponibile), la data di consegna e la natura del difetto.

9.5 Qualsiasi Prodotto per il quale non sia stata sollevata alcuna contestazione conformemente alle procedure ed ai termini qui sopra indicati viene considerato approvato ed accettato dall'Acquirente.

9.6 In nessun caso agenti, clienti o intermediari del Venditore hanno il potere di rappresentare ed impegnare quest'ultima nei confronti dell'Acquirente o di altre terze parti. A tal fine ogni comunicazione relativa a vizi e difetti dei Prodotti sarà invalida ed inefficace qualora sia stata fatta ad agenti, clienti o intermediari del Venditore, ovvero in forme o modalità diverse da quelle sopraindicate.

10. Riserva di proprietà

10.1 I Prodotti rimangono di proprietà del Venditore fino alla data in cui l'Acquirente non abbia provveduto al pagamento dell'intero prezzo degli stessi e di tutte le somme dovute al Venditore.

10.2 Nel caso in cui nel paese in cui l'Acquirente ha la propria sede, per la validità della riserva di proprietà a favore del Venditore sia necessario l'espletamento di formalità amministrative o legali quali, senza alcuna limitazione, la registrazione dei Prodotti in pubblici registri, ovvero l'apposizione sugli stessi di appositi sigilli, l'Acquirente si impegna fin d'ora a collaborare con il Venditore e a porre in essere tutti gli atti necessari al fine di far ottenere a quest'ultimo un valido diritto, anche nei confronti di eventuali soggetti terzi, con riferimento alla riserva di proprietà.

11. Forza Maggiore

11.1 Sia l'Acquirente che Fami potranno sospendere l'esecuzione dei loro obblighi contrattuali quando tale esecuzione sia resa impossibile o irragionevolmente onerosa da un impedimento imprevedibile ed indipendente dalla loro volontà quale a titolo esemplificativo, non esaustivo, scioperi, epidemia e/o pandemia, boicottaggi, serrate, incendi, guerre, sommosse e rivoluzioni, requisizioni, embarghi, interruzioni di energia.

11.2 La Parte che desiderasse avvalersi della presente clausola dovrà comunicare immediatamente per iscritto, a mezzo posta elettronica certificata, all'altra il verificarsi e la cessazione delle circostanze di forza maggiore.

11.3 Qualora la sospensione dovuta a forza maggiore duri più di otto settimane, ciascuna Parte avrà il diritto di risolvere l'Ordine, previo un preavviso di 10 giorni, da comunicarsi all'altra per iscritto, mediante raccomandata con ricevuta di ritorno o mediante comunicazione a mezzo posta elettronica certificata.

11.4 In ogni caso, resta inteso che il Venditore avrà diritto di ottenere il pagamento dei Prodotti eventualmente già consegnati, oltre al rimborso di eventuali spese già sostenute.

12. Mutamento nelle condizioni patrimoniali dell'Acquirente

12.1 Fami avrà diritto a sospendere l'adempimento delle obbligazioni derivanti dalla fornitura dei Prodotti nel caso in cui le condizioni patrimoniali dell'Acquirente divenissero tali da porre in serio pericolo il conseguimento della controprestazione, salvo che sia prestata idonea garanzia. Resta inteso che il Venditore avrà diritto di ottenere il pagamento dei Prodotti eventualmente già consegnati, oltre al rimborso di eventuali spese già sostenute.

13. Proprietà intellettuali

13.1 I Diritti di Proprietà Intellettuale sono di totale ed esclusiva proprietà del Venditore e la loro comunicazione o utilizzo nell'ambito delle presenti Condizioni non crea, in relazione ad essi, alcun diritto o pretesa in capo all'Acquirente. Quest'ultimo si obbliga a non compiere alcun atto incompatibile con la titolarità dei Diritti di Proprietà Intellettuale.

13.2 L'Acquirente dichiara che: a) il Venditore è l'esclusivo titolare dei Marchi; b) si asterrà dall'utilizzare e da registrare marchi simili e/o confondibili con i Marchi; c) utilizzerà i Marchi esclusivamente in ottemperanza alle istruzioni del Venditore ed esclusivamente per i fini di cui alle presenti Condizioni.

14. Foro competente e legge applicabile

14.1 Per qualunque controversia derivante o connessa alle presenti Condizioni Generali di vendita e/o al singolo Contratto quali, a titolo meramente esemplificativo e non esaustivo, controversie relative alla loro esistenza, validità, interpretazione, efficacia, esecuzione, è competente a decidere in via esclusiva il Tribunale di Vicenza, anche qualora il Contratto presenti elementi di internazionalità.

14.2 In deroga a quanto sopra stabilito, il Venditore ha comunque la facoltà di portare la controversia davanti al giudice competente presso la sede dell'Acquirente.

14.3 Le presenti Condizioni Generali di vendita e/o ogni singolo Contratto sono interamente soggetti alla legge italiana e interpretati secondo la stessa, anche qualora il Contratto presenti elementi di internazionalità, con espressa esclusione della Convenzione di Vienna del 1980.

15. Privacy

15.1. L'Acquirente dichiara di aver ricevuto tutte le informazioni previste ai sensi dell'art. 13 del Regolamento UE n. 2016/679 (GDPR) e presta il consenso al trattamento dei dati personali per le finalità di cui alle presenti condizioni generali di vendita e di essere stato informato che in relazione ai dati conferiti è possibile esercitare i diritti previsti dal D. Lgs. n. 196/2003 e del Regolamento UE n. 2016/679 (GDPR). Il Venditore dichiara che il titolare del trattamento dei dati raccolti è Fami S.r.l., con sede legale in Rosà (VI), Via Stazione Rossano n. 13, partita IVA e codice fiscale 03498610249

16. Osservanza della L. 231/2001

16.1 L'Acquirente prende atto che Fami S.r.l. ha adottato ed attua un Modello di Organizzazione, Gestione e Controllo ex D.lgs. 231/01, con i relativi Codice Etico e Sistema Disciplinare i cui dettagli possono essere visionati sul sito aziendale www.famispaspa.com. L'Acquirente aderisce ai principi al succitato Modello di organizzazione, gestione e controllo nonché ai suoi allegati e si impegna a rispettarne i contenuti, i principi, e le procedure e, in generale, ad astenersi da qualsivoglia comportamento atto a configurare le ipotesi di reato indicate nel D.lgs 231/01 e sue successive modifiche ed integrazioni e riportate nel predetto Modello di organizzazione, gestione e controllo. L'Acquirente si impegna inoltre a rispettare e a far rispettare ad eventuali suoi collaboratori, tutti i principi contenuti nella suddetta documentazione ed i Protocolli comportamentali previsti dalla nostra organizzazione ai sensi del D. Lgs. 231/2001 ed allegati al presente contratto. La violazione delle regole previste dai sopraccitati documenti rappresenterà grave inadempimento contrattuale.

17. Disposizioni finali

17.1 Qualora una delle Parti ometta di intraprendere un'azione giudiziale o di esercitare un diritto in base alle presenti Condizioni, tale comportamento di acquiescenza non potrà essere interpretato come una definitiva rinuncia ad esercitare in futuro la stessa azione giudiziale o lo stesso diritto.

17.2 La vendita dei Prodotti da parte di Fami all'Acquirente non fa sorgere a favore di quest'ultimo un diritto di esclusiva territoriale né consente all'Acquirente di assumere la qualità di distributore o concessionario di Fami.

17.3 L'invalidità in tutto o in parte di singole disposizioni delle presenti Condizioni non inficia la validità delle restanti previsioni.

BREVETTI

Alcuni componenti sono protetti da modello di design comunitario e/o brevetto di invenzione industriale.

BIN CART



WWW.FAMISPA.COM

VIA STAZIONE ROSSANO 13
36027 ROSÀ (VICENZA) ITALIA

TEL. +39 0424 58 54 55
FAX +39 0424 58 54 70

E-MAIL: INFO@FAMISPA.IT

TIMBRO RIVENDITORE